

■ Kalesinterflex

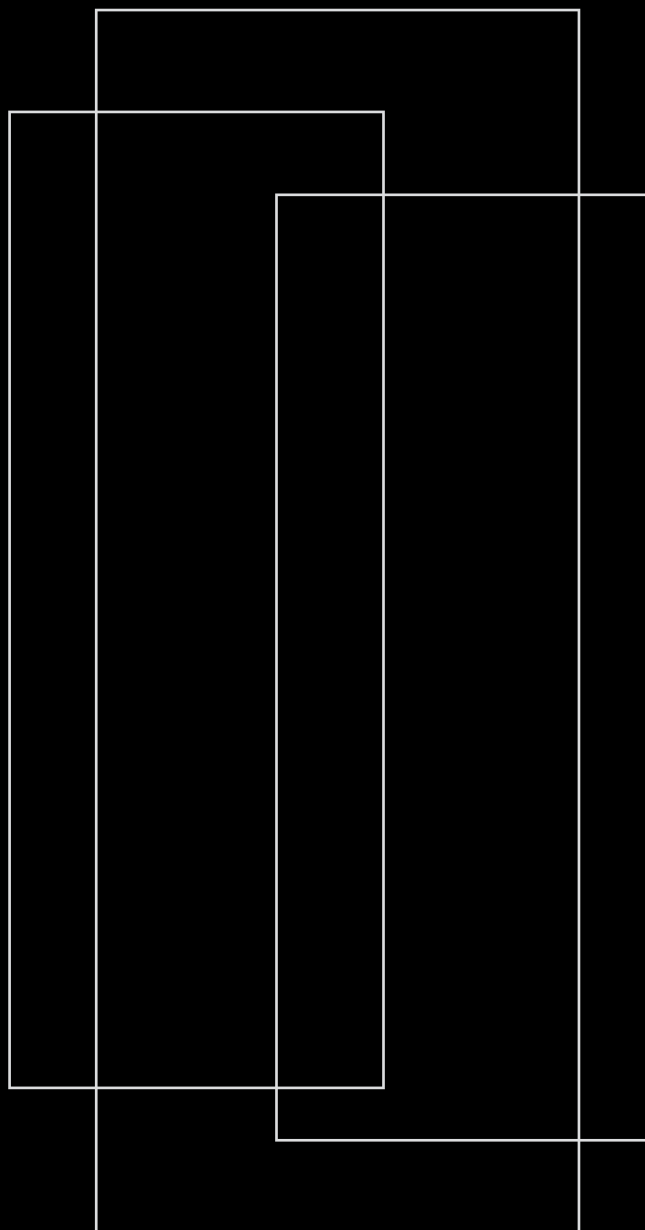

FACADE CATALOG | CEPHE KATALOĞU



İNDEX

içindekiler

Leader In Türkiye
6 Türkiye'de Lider

Ultimate Covering Material
9 Ultimate Covering Material

Innovation
10 İnovasyon

Resistant
11 Dayanıklılık

Features
12 Özellikler

Thicknesses
14 Kalınlıklar

Sizes
15 Ebatlar

Surfaces
16 Yüzeyler

Usage areas & Our services
18 Kullanım Alanları & Hizmetlerimiz

We are ready to take care of
20 İyi bakmaya hazırız

Kaleguard
22 Kaleguard

Look Index
24 Görünümler

Local Projects
28 Yurt İçi Projeler

Worldwide Projects
114 Yurt Dışı Projeler

Technology and Products
146 Teknoloji ve Ürünler

Technical Information & Characteristics
180 Teknik Bilgiler & Özellikler



If you can say "what a relief!" as you step in your home...
If you can see more than four-walls while "inside"...
If you can reflect your own colors, own delights as you wish...
If you can host your dreams as much as your friends for dinner...
If you can raise a flower, a child, or a hope within the peace of your home...
Then, your home becomes your world,
and the world is your home!
And us,
With our design-oriented durable products, with our not only inspirational but
also sustainable and economical solutions, with our unique balance between the
functionality and esthetics, we are ready to reflect your imagination and style to every
corner of your home; to take good care of your home, your world, and you.

"Kale | #CareForYourWorld

Eve adınızı attığınız anda "dünya varmış" diyebiliyorsanız eğer...
Dört duvardan fazlasını görüyorsanız "içeride"...
Kendi renklerinizi, kendi zevklerinizi yansıtabiliyorsanız gönlünüzce....
Dostlarınız kadar düşlerinizi ağırlayabiliyorsanız sofralarınızda...
Bir çiçeği, bir çocuğu ya da belki bir ümidi yeşertebiliyorsanız evinizin huzurunda...
İşte o zaman, eviniz sizin dünyanız,
dünya sizin eviniz!
Ve biz,
Tasarımı odağa alan dayanıklı ürünlerimiz, ilham verici olduğu kadar sürdürülebilir ve
tasarruflu çözümlerimiz, fonksiyonellik ve estetik arasında kurduğumuz eşsiz denge ile
hayallerinizi ve tarzınızı yuvanızın her köşesine yansıtabilmek;
evinize, dünyanıza ve size iyi bakmak için hazırız.

"Kale | #İyiBak Dünyana

EUROPE
AVRUPA

5TH
'İNCİ

WORLD
DÜNYA

17TH
'İNCİ

KALE. LEADER IN TÜRKİYE, PIONEER IN THE WORLD.

KALE. TÜRKİYE'DE LİDER,
DÜNYADA ÖNCÜ.

Ranks 5th in Europe, 17th in the World in ceramic tile production capacity

First ceramic tile production in Türkiye

First tile export from Türkiye

First company in the world to invest in and begin production with the Kalesinterflex (porcelain slab) technology

Üretim kapasitesi olarak Avrupa'nın 5'inci, Dünya'nın 17'inci şirketi

Türkiye'nin ilk seramik üretimi

Türkiye'nin ilk seramik ihracatı

Dünyada Kalesinterflex (porselen plaka) teknolojisine yatırım yapan ve bu teknoloji ile üretime geçen ilk şirket

Production Complex
Area of
1.25 M
sqm

Üretim Kompleksi Alanı
1.25 Milyon m²

With an Indoor
Area of
650.000
sqm

650.000 m² Kapalı Alan Üretimi

Kalesinterflex
Production of
1.6 M
sqm

1.6 Milyon m²
With an Indoor
Kalesinterflex Üretimi

A Total Production
Capacity of
68 M
sqm / Year

Toplam Üretim Kapasitesi
68 Milyon m² / yıl

18

Production Plants
18 Üretim Fabrikası



Ultimate Covering Material

Ultimate Covering Material

There is a place where imaginations run with a boundless energy.

Art and science together as one.

Where impossible is an illusion. A figment. A fiction.

We know this place because we live and breathe ceramics of incomparable beauty and quality.

Here we see homes as they were meant to be.

No dream too great. No vision too stunning.

It's what's possible when everything you do rests on deeply held principles.

Technology that inspires with its fusion of innovation, form, function and performance in ways that are deeply enduring.

Design that is deeply authentic, breathing life into every dream, every vision and that brings new meaning to the spaces in which we live.

A resolve to make sustainability a way of life as much as it is a way of doing business. Caring for the future by caring for the world.

It's what happens when you reimagine what the ultimate covering material could be.

It's what happens when you reimagine possible.

Hayat, hayal edince güzel. Yaşam alanlarınıza nasıl yeni anlamlar kazandırabiliriz?

Dünyayı düşünerek başlayalım mı mesela?

Sürdürülebilir bir ürün düşünün... Evinizin her yerinde. İlham veren. Ama aynı zamanda ekonomik çözümler de üreten.

Sadece çevre dostu değil, sizin de dostunuz. İşlevsellik ve estetik arasında benzersiz bir denge sunan bir ürün.

Hiç aklınıza gelmeyecek bambaşka yerlerde karşınıza çıktığını düşünün. Her seferinde şaşırtıyor. Heyecanlandırıyor.

Yenilikçi teknolojiyle, hayata, dünyaya ve insana değer katıyor.

Şimdi gözlerinizi kapatın. Dünyayı değiştiren bu yenilikle hayalinizdeki mekanı tasarladığınızı düşünün. Rafine bir zevkle. İncelikle. Zerafetle.

Ve gözlerinizi dünyaya yeniden açın.

Hayal ettiğiniz ne varsa, hayat bulmuş bir şekilde karşınızda.

Biz Kalesinterflex'i üretirken hep daha güzelini hayal ettik. Çünkü hayat, hayal edince güzel.

Innovation for better living

Daha iyi bir yaşam için inovasyon

Making a difference with its environmentally sensitive technology, Kalesinterflex is manufactured using less energy and fewer raw materials than standard ceramic tiles.

Çevreye duyarlı teknolojiyle fark yaratan Kalesinterflex, standart seramik karolara göre daha az enerji ve ham madde kullanılarak üretilir.

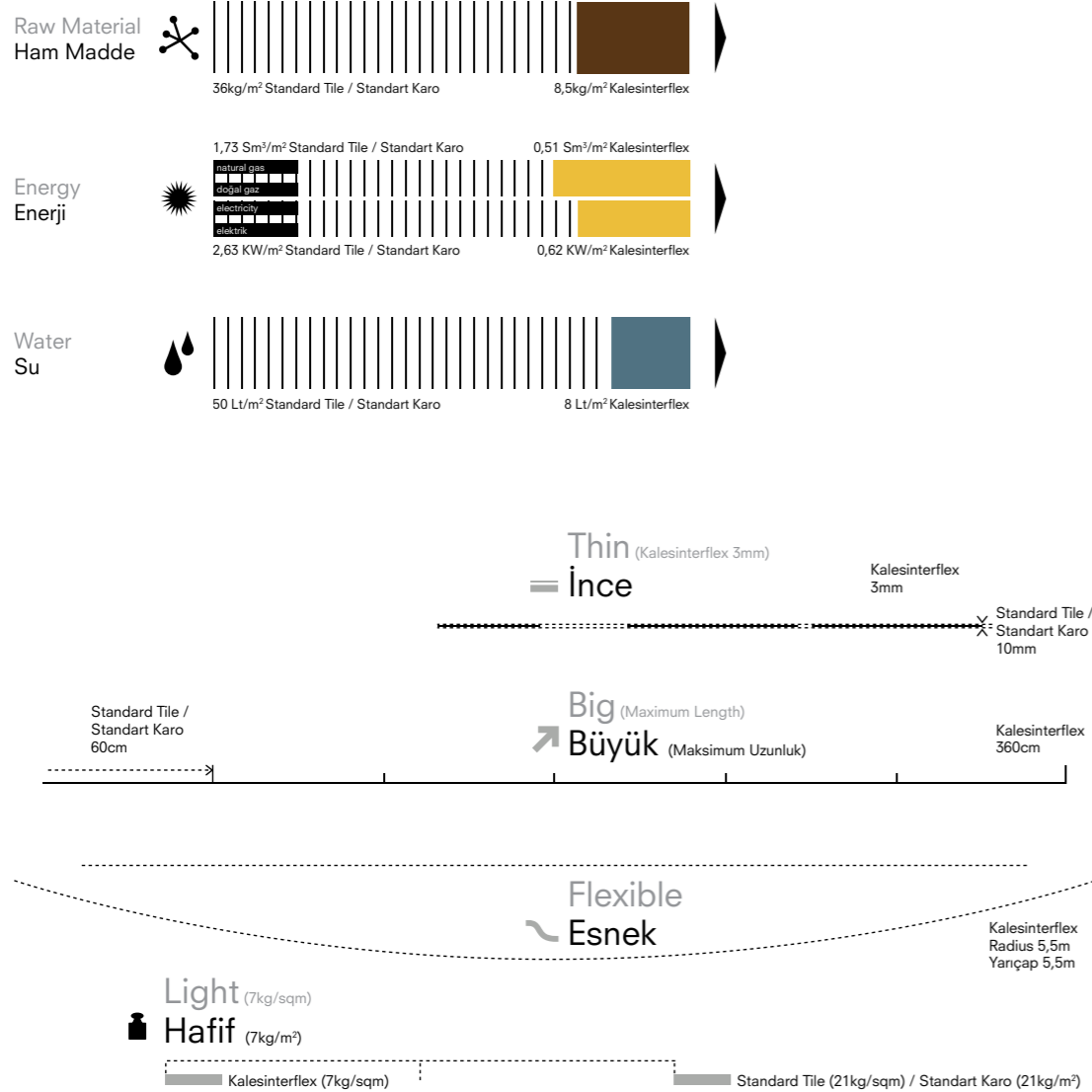

Preferred as the facade cladding of prestigious buildings, Kalesinterflex offers long-lasting use thanks to its surface that is **super resistant to** sunlight and different weather conditions.

Prestijli mimarilerin dış cephe kaplaması olarak tercih edilen Kalesinterflex, UV ışınlarına ve farklı hava koşullarına karşı **üstün dayanıklılık** gösteren yüzeyiyle uzun ömürlü kullanım sunuyor.

Features / Özellikler

Everything that must be in a porcelain slab and more...
Designed to shape the architecture of the future,
Kalesinterflex is equipped with superior features to
ensure flawless performance under any condition.

Bir seramikte olması gereken her şey ve daha fazlası...
Geleceğin mimarisini şekillendirmek için tasarlanan
Kalesinterflex, her koşulda kusursuz performans
göstermesi için üstün özelliklerle donatıldı.

WEIGHT*

A 3mm-thick Kalesinterflex slab weighs
7kg/sqm while a 5mm-thick Kalesinterflex slab
weighs 11.5kg/sqm.



AĞIRLIK*

3mm kalınlığındaki bir Kalesinterflex levha
7kg/m², 5mm kalınlığındaki bir Kalesinterflex
levha 11,5kg/m² ağırlığındadır.

FLEXIBILITY

The convex flexibility radius of a
3mm-thick Kalesinterflex Fit slab
is 4.5m.

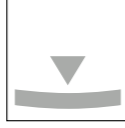

ESNEKLİK

3mm kalınlığındaki Kalesinterflex fit levhanın
içbükey esneklik yarıçapı 4,5m,
dışbükey esneklik yarıçapı 5,5m'dir.

NON-FLAMMABLE (FLAME RESISTANT)

Kalesinterflex is totally fire resistant
and non-flammable.



YANMAZ (ALEVE DAYANIKLI)

Kalesinterflex ateşe tamamen dayanıklı,
alev almaz ve yanmaz niteliktedir.

CHEMICAL RESISTANCE

Kalesinterflex is resistant to chemicals (acids and bases)
due to its porcelain ceramic structure and glaze layer
on its surface.



KİMYASALLARA DAYANIKLILIK

Kalesinterflex yüzeyindeki koruyucu sır tabakası ve porselen
yapısı sayesinde en güçlü kimyasallara
(asitlere ve bazlara) karşı dayanıklıdır.

CUTTING

It can be cut with standard glass, ceramic
cutters and computer controlled automatic
cutting machines in the required dimensions.

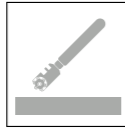

KESME

Kalesinterflex, standart cam ve seramik kesicileri
ve bilgisayar kontrollü otomatik kesme ve delme
makinaları ile istenen boyutlarda kesilebilir.

DRILLING

Kalesinterflex can be drilled with glass
drills as well as with other automatic
drilling devices.



DELME

Kalesinterflex, cam ya da benzer malzemeler için
kullanılan alet ve matkaplar ile delinebileceği gibi
diğer bilinen otomatik aletlerle de delinebilir.

HIGH HEAT AND FROST RESISTANCE

Kalesinterflex's surface is equipped with advanced technology
to accommodate various climate conditions. It maintains its
durability against sudden changes in heat and frost.



YÜKSEK SICAKLIĞA VE SOĞUĞA DAYANMA DİRENCİ

Kalesinterflex'in üstün teknolojiyle donatılan yüzeyi farklı iklim
koşullarına uygun olarak tasarlanmıştır. Ani ısı değişikliklerine
ve dona karşı sağlamlığını korur.

EASE OF CLEANING

Kalesinterflex has a smooth surface on which dirt
does not accumulate. If required it can be cleaned
with water and known cleaning agents.



TEMİZLEME

Kalesinterflex'in düzgün yüzeyi kir tutmayan bir
yapıya sahiptir. Gerektiği takdirde su ve bilinen
temizlik ürünleri ile kolayca temizlenebilir, lekelenmez.

ANTI-GRAFFITI

Easy to wipe and clean pollutants
like crayon, graffiti, permanent
marker, board marker.



ANTI-GRAFİTİ

Boya kalem, keçeli kalem ve tahta
kalem yazıları kolayca silinir ve
temizlenir.

PHOTOCATALYTIC

Kalesinterflex is photocatalytic thanks to its
Nano-tech coating surface. Kalesinterflex
cleans itself with rain and sunlight.

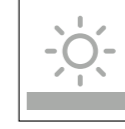

FOTOKATALİTİK

Kalesinterflex Nano Kompozit yüzey özelliği
sayesinde fotokataliktir. Leke tutmaz, yağmur ve
güneş ışığı sayesinde lekeler temizlenir.

HYGIENIC

Protects both outdoor and indoor, even in poorly lit environment.
Hygienic; resistant to bacteria, mould and fungus. The
antibacterial feature of Kalesinterflex is approved by TÜBİTAK.
(The Scientific and Technological Research Council of Türkiye)



HİJYENİK

Yetersiz aydınlatmaya sahip ortamlarda dahi hem iç mekanları hem
de dış mekanları bakterilerden korur. Hijyeniktir; bakterilere, küfe
ve mantara karşı dayanıklıdır. Kalesinterflex Antibakteriyel Ürün
Güvencesi TÜBİTAK tarafından onaylıdır.

ECO-FRIENDLY

Produced with an environmentally-friendly technology,
Kalesinterflex has Ecospecifier certificate. Compared to the
traditional ceramic production process, its gas and dust emission
is 20 times, its CO2 emission is 1000 times less.



ÇEVRE DOSTU

Çevreye duyarlı bir teknoloji ile üretilen Kalesinterflex,
Ecospecifier belgesine sahiptir. Geleneksel seramik üretim
süreçleriyle karşılaştırıldığında gaz ve toz emisyonu 20 kat, CO2
emisyonu ise 1000 kat daha azdır.

HIGH STAIN RESISTANCE

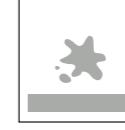

YÜKSEK LEKE DİRENCİ

HIGH ABRASION RESISTANCE

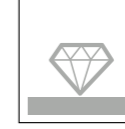

YÜKSEK AŞINMA DİRENCİ

HIGH RESISTANCE TO UV RAYS

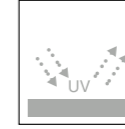

UV IŞINLARINA YÜKSEK DİRENÇ

LOW WATER ABSORPTION (NEAR ZERO)



DÜŞÜK SU EMMELİ (0'A YAKIN)

EVERLASTING



UZUN ÖMÜRLÜ

HIGH SCRATCH RESISTANCE

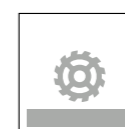

YÜKSEK ÇİZİLME DİRENCİ

*The specified weights reflect average values and may vary depending on the product.

*Belirtilen rakamlar ortama değerlerdir. Farklı ürünlerde değişkenlik gösterebilir.

Thicknesses / Kalınlıklar

Manufactured with thickness alternatives of 3mm, 5mm, 6mm, 12mm and 20mm Kalesinterflex effortlessly adapts to different areas of use.

3mm, 5mm, 6mm, 12mm ve 20mm kalınlık alternatifleriyle üretilen Kalesinterflex, farklı kullanım alanlarına kolaylıkla uyum sağlar.

20mm



12mm



6mm



5mm



3mm



IMPERIUM / İSTANBUL

Sizes / Ebatlar

Türkiye's largest thin slab, Kalesinterflex allows for comfortable architecture with its standard dimension alternatives of 100x300cm, 120x360cm and 160x320cm. It may be cut and installed in any size as required by a project.

Türkiye'nin en büyük porselen plakası olan Kalesinterflex, 100x300cm, 120x360cm ve 160x320cm ana üretim ebat alternatifleri ile mimariye rahatlık sunar. Kullanılacağı projelere uygun bir şekilde kesilip monte edilebilir.



Standard Sizes / Standart Boyutlar

160x320cm - 62.99" x 125.98" inches

120x360cm - 48x144 inches

100x300cm - 40x120 inches

Surfaces / Yüzeyler

Kalesinterflex Matte Surface
Kalesinterflex Mat Yüzey



Kalesinterflex
Soft Matte Surface
Kalesinterflex Soft Mat Yüzey



Kalesinterflex
Polished Surface
Kalesinterflex Parlak Yüzey



Kalesinterflex Satin Surface
Kalesinterflex Satin Yüzey



Kalesinterflex is manufactured with two different surface alternatives: matte and polished. The matte surface has matte, gleaming and structured options.

Kalesinterflex, mat ve parlak olmak üzere iki farklı yüzey alternatifleriyle üretilmektedir. Mat yüzeyi mat, parıltılı ve kalıplı seçeneklere sahiptir.

Türkiye's largest polished ceramic slab, Kalesinterflex may be used in numerous parts of a building.

Türkiye'nin en büyük parlak seramiği olan Kalesinterflex, yapıların birçok bölümünde tercih edilebilir.



We offer innovative solutions that combine aesthetics and durability in facade applications. We create an eye-catching look on the building facades with thin and large-size slabs manufactured with high technology. With surfaces that deliver the performances expected from the building shell, we protect the facades for years like the first day and take our place in environmentally friendly buildings as a sustainable construction material.

Cephe uygulamalarında estetik ve dayanıklılığı bir araya getiren yenilikçi çözümler sunuyoruz. Yüksek teknoloji ile üretilen, ince ve büyük boyutlu plakalarla binaların dış cephelerinde göz alıcı bir görünüm oluşturuyoruz. Yapı kabuğundan beklenen performanslara cevap veren yüzeylerle cepheleri yıllarca ilk günkü gibi koruyor, sürdürülebilir yapı malzemesi olarak çevre dostu binalarda yer alıyoruz.

Usage areas / Kullanım Alanları

For facade applications where durability and aesthetics are prioritized, we aim to match the right product with the right practitioner and the right project at every stage of the sales process with the assistance of our technical sales specialists.

Dayanıklılığın ve estetiğin ön planda tutulduğu dış cephe uygulamalarında, uzman teknik satış kadromuz ile satış sürecinin her aşamasında doğru ürünün, doğru cephe uygulayıcısı ve doğru projeyle eşleştirilmesini hedefliyoruz.

Our services / Hizmetlerimiz

We prepare detailed technical documents and specifications in cooperation with the relevant departments and academic cadres from the universities to ideally reveal the technical features and usage advantages of our product groups. We share information with industry professionals to ensure the support of academic circles for the technical competencies of our products.

Ürün gruplarımızın teknik özelliklerini ve kullanım avantajlarını en iyi şekilde ortaya koyabilmek için üniversitelerin ilgili bölümleri ve akademik kadrolarıyla iş birliği yaparak detaylı teknik dokümanlar ve şartnameler hazırlıyoruz. Bilgileri sektör profesyonelleriyle paylaşarak ürünlerimizin teknik yeterliliklerinin akademik çevrelerce de desteklenmesini sağlıyoruz.

We are constantly in touch with significant stakeholders in the sector, including architectural groups, contractors, and facade practitioners. We share with them technical specifications, principle detail drawings, and static calculation studies that will enable the projects to be completed.

Mimari gruplar, müteahhitler, cephe danışmanları gibi sektörün önemli paydaşları ile sürekli iletişim halinde olup, projelerin başarıyla tamamlanmasını sağlayacak teknik şartnameler, prensip detay çizimleri ve statik hesap çalışmalarını paylaşıyoruz.

We provide technical guidance for special detail and grid works that will meet the aesthetic and functional requirements of the project in facade design.

Cephe tasarımında projenin estetik ve fonksiyonel gereksinimlerini karşılayacak özel detay ve karolaj çalışmaları için teknik yönlendirmeler yapıyoruz. Saha uygulamalarında uygulama ekiplerine teknik destek sağlamak ve uygulamaların şartnamelere uygun olarak gerçekleştirilmesini garantilemek amacıyla, projeleri yakından takip ediyoruz.

We closely monitor the projects to give technical support to the teams in field applications and to ensure that they are carried out following the specifications.

Kapsamlı ve detaylı yaklaşımımızla dış cephe uygulamalarında sadece estetik ve fonksiyonel gereksinimleri karşılamakla kalmıyor, yapıların uzun ömürlü ve sürdürülebilir olmasını da sağlıyoruz.

Due to our comprehensive and detailed approach, we meet aesthetic and functional requirements in facade applications while also ensuring the longevity and sustainability of buildings.



We are ready to take care of your home, your world, and you...

Evinize, dünyanıza ve size iyi bakmaya hazırız...

Thanks to the Kalesinterflex Porcelain Slab, which was designed with sustainable production technologies as one of the special materials of architecture, we offer functional and environmentally friendly solutions.

Compared to standard ceramics, we are producing a slab that enables;

Sürdürülebilir üretim teknolojileriyle hazırlanan Kalesinterflex Porselen Plaka ile fonksiyonel ve çevreci çözümler sunuyoruz. Standart seramiklere göre;

57% less
57% daha az

Raw Material Consumption:
Compared to standard ceramic tiles,
ham madde tüketimi

20% less
20% daha az

Water Consumption:
Compared to standard ceramic tiles,
su tüketimi

47% less
47% daha az

Natural Gas Consumption:
Compared to standard ceramic tiles,
doğalgaz tüketimi

90%

Logistics:
Compared to standard ceramic tiles,
ürün taşınabilirliği sağlıyoruz.

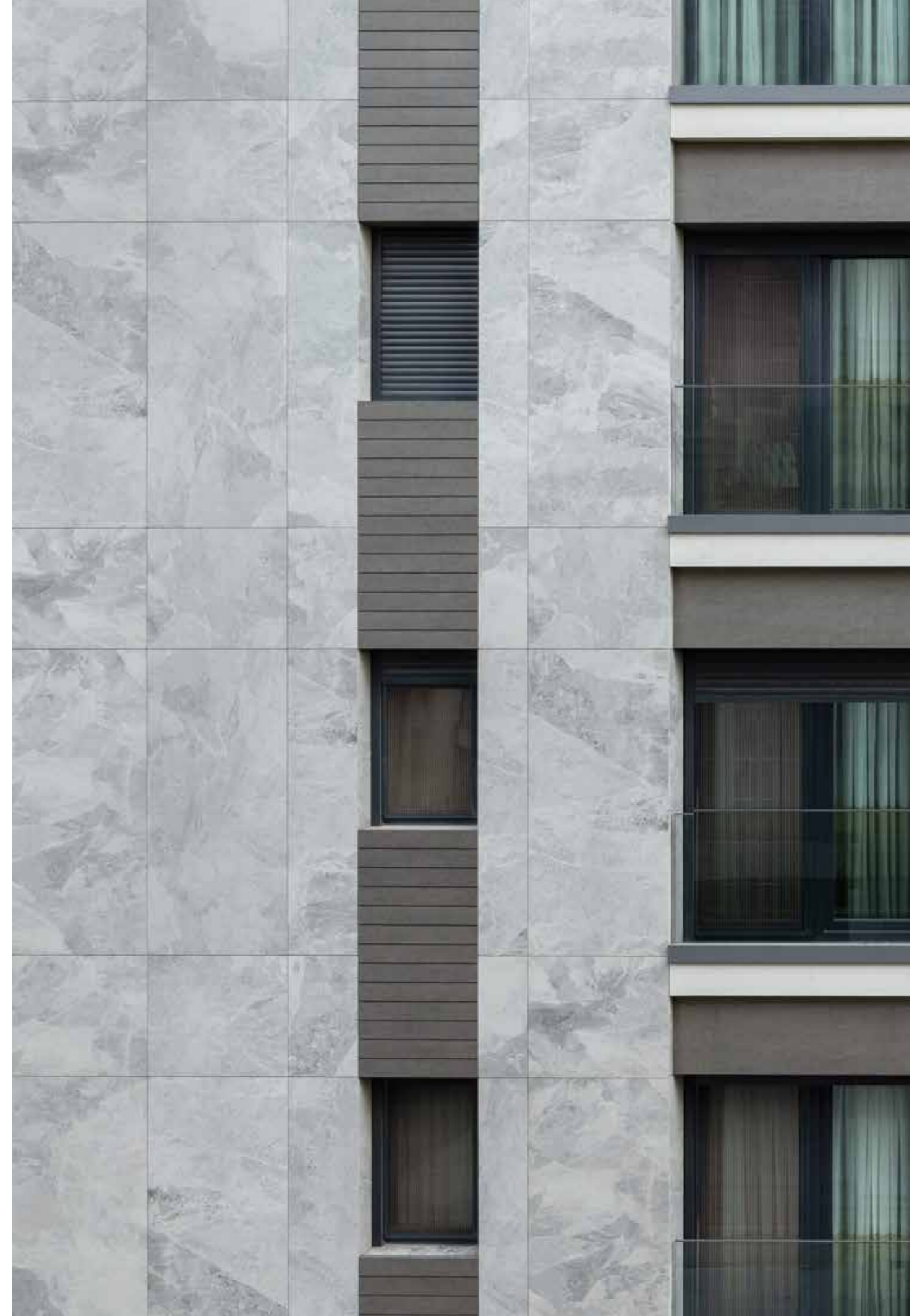

Kaleguard / Kaleguard

We use science and technology for human health. The health of you and your loved ones are under protection thanks to Kaleguard Surface Protection Technology.

Bilim ve teknolojiyi insan sağlığı için kullanıyoruz. Kaleguard Yüzey Koruma Teknolojisi ile sizin ve sevdiğinizlerin sağlığı koruma altında.

We equip ceramic surfaces with superior protection with Kaleguard technology which is developed for the first time in the world.

Dünyada sadece Kale'de bulunan Kaleguard teknolojiyle, seramik yüzeyleri üstün koruma özelliğiyle donatıyoruz.



3 Superior features designed For living spaces!

Yaşam alanları için tasarlanan 3 üstün özellik!



Kaleguard

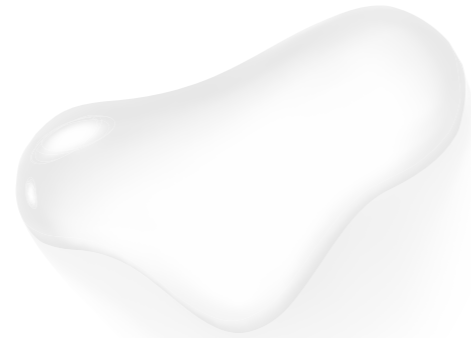

Effective protection against bacteria! Bakterilere karşı etkili koruma!

Preventing the formation of bacteria mold, fungus and bacteria; Kaleguard technology offers maximum hygiene everywhere. It protects your health in many living areas open to public use such as homes, hotels, hospitals, shopping malls, poolside and schools.

Küf, mantar ve bakteri oluşumunu önleyen Kaleguard teknoloji, her yerde maksimum hijyen sunuyor. Ev, otel, hastane, alışveriş merkezi, havuz kenarı ve okul gibi toplu kullanıma açık birçok yaşam alanında sağlığını koruyor.

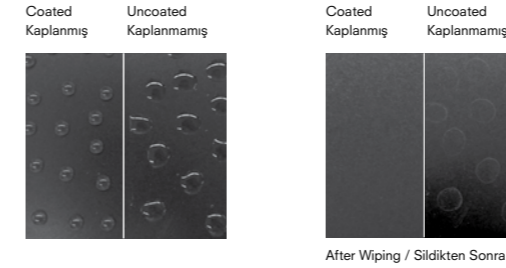

Self-cleaning hygienic ceramics! Kendi kendini temizleyen hijyenik seramikler!

Stains and dirt caused by different environmental effects cannot hold on to ceramic surfaces thanks to Kaleguard technology. While providing a clean appearance indoors and outdoors, it designs healthy living spaces with its unique technology.

Farklı çevresel etkilerle oluşacak leke ve kirler Kaleguard teknoloji ile seramik yüzeylerde tutunmıyor. İç ve dış mekanlarda temiz bir görünüm sağlarken, benzersiz teknolojiyle sağlıklı yaşam alanları tasarlıyor.

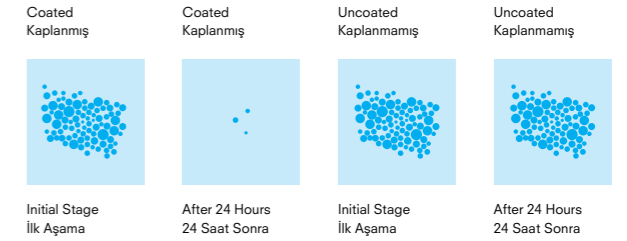

Look Index / Görünümler

SOLID COLORS / DÜZ RENKLER

INNOVATION



LEDER

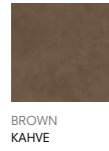

CEMENT / ÇİMENTO

LUXURY CEMENT

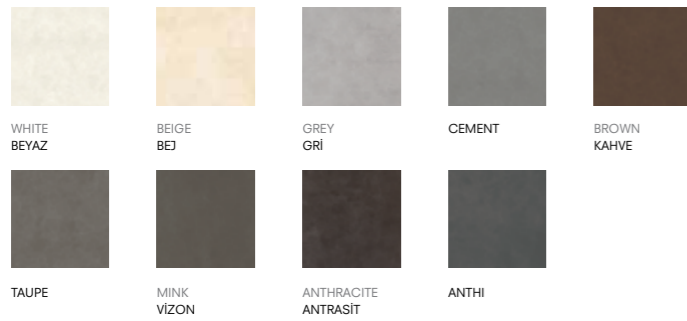

HIGHWAY

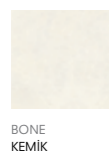

ARCHE



HUED



FACTORY



STONE / DOĞALTAŞ

NATURAL STONE

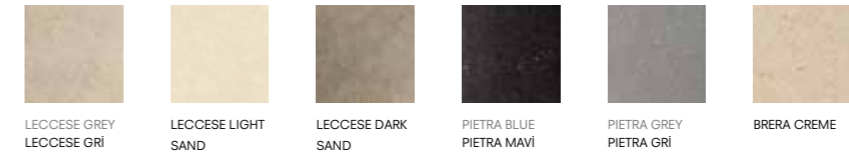

C-STONE

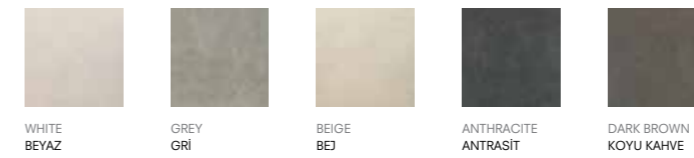

OCEAN

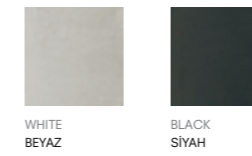

STONELAND



OMNITECH



UPTOWN



STONE GALLERY

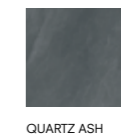

EARTH COLLECTION



CALCARIO COLLECTION



Look Index / Görünümler

METALLIC / METALİK

METALLIC

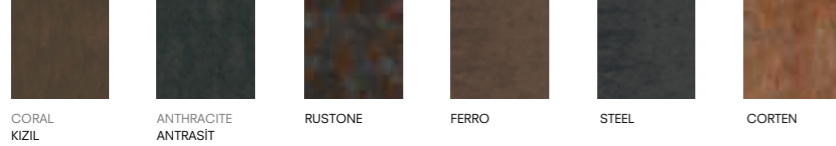

WOOD / AHŞAP

HOLLYWOOD

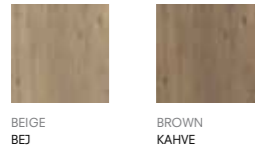

WOODLINE

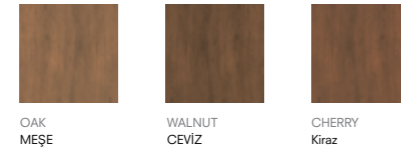

PLANK



SHELL WOOD

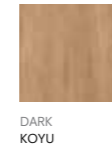

MARBLE BLACK & WHITE / SİYAH & BEYAZ MERMER

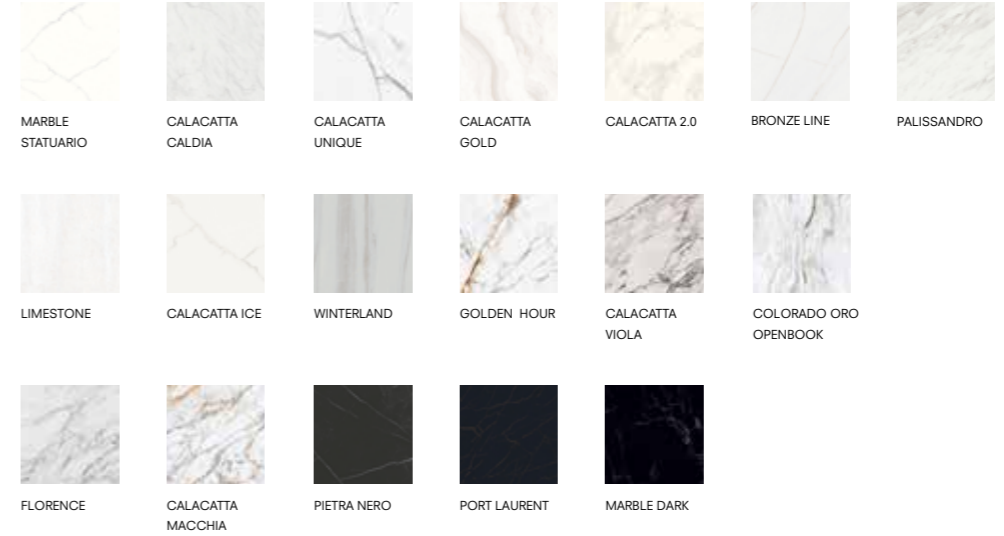

MARBLE EXCLUSIVE / MERMER EXCLUSIVE



MARBLE TIMELESS / KLASİK MERMER





Local Projects

Yurt İçi Projeler



FACADE / DIŞ CEPHE

Ankara City Hospital / Ankara Şehir Hastanesi

Ankara City Hospital, Ankara — Kalesinterflex + Porcelain Ceramic - Kalesinterflex Innovation Coral, Innovation Dark Grey, Innovation Blue, Innovation Saffron, Innovation Turquoise, Innovation Beige Grey / 60x120cm Cement 2.0 White / Hidden Clips System, Clips System
NKY ARCHITECTS & ENGINEERS

Ankara Şehir Hastanesi, Ankara — Kalesinterflex + Porselen Seramik - Kalesinterflex Innovation Kızıl, Innovation Koyu Gri, Innovation Mavi, Innovation Safran, Innovation Turkuaz, Innovation Bej Gri / 60x120cm Cement 2.0 Beyaz / Gizli Klipsli Sistem, Klipsli Sistem
NKY MİMARLIK & MÜHENDİSLİK





FACADE / DIŞ CEPHE

Çamlıvadi / Çamlıvadi

Çamlıvadi, İstanbul — C-Stone Anthracite, Luxury Cement Grey, Shellwood Dark / 120x360cm / Hidden Clips System
SPDO ARCHITECTS

Çamlıvadi, İstanbul — C-Stone Antrasit, Luxury Cement Gri, Shellwood Dark / 120x360cm / Gizli Klipsli Sistem
SPDO MİMARLIK

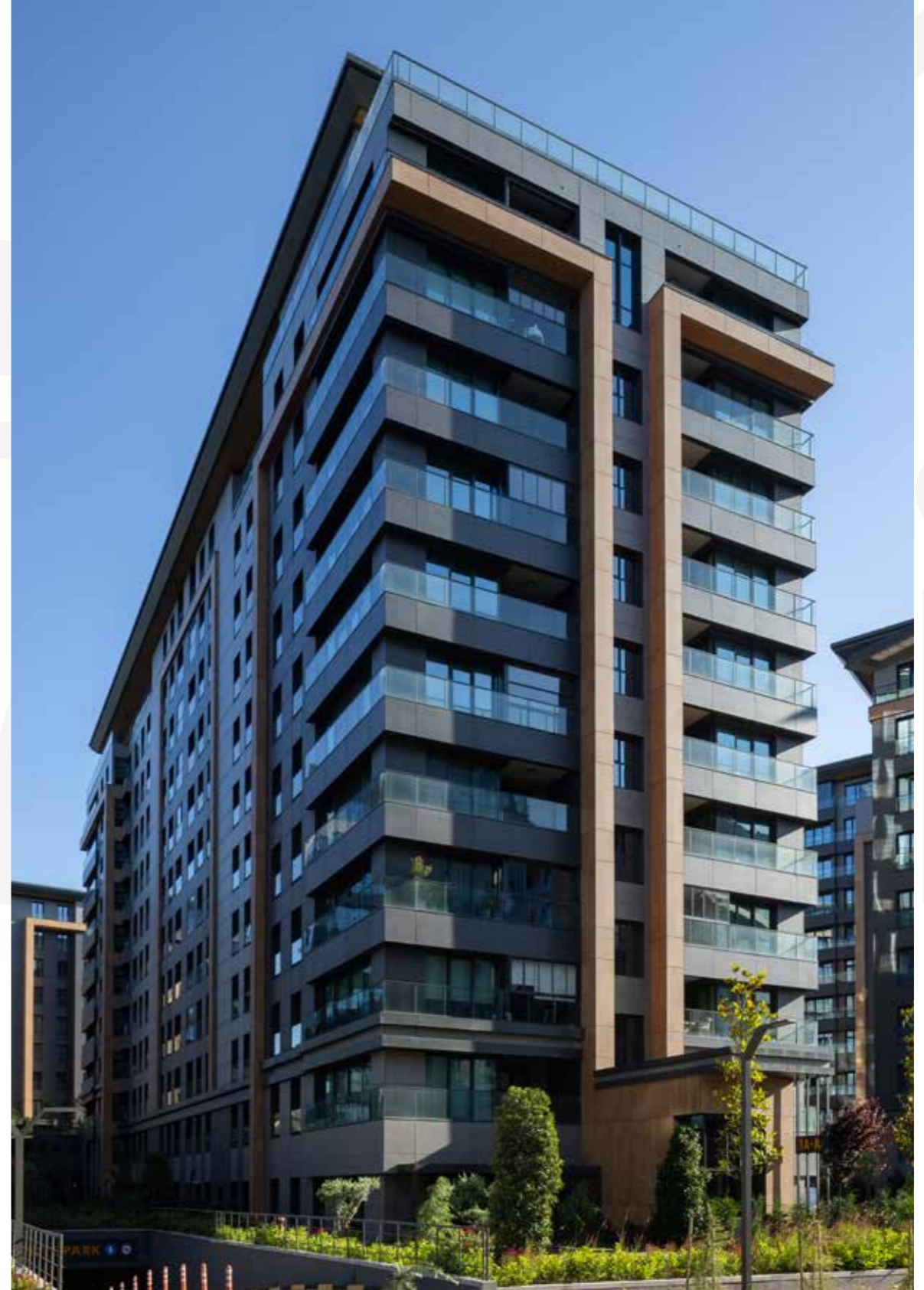

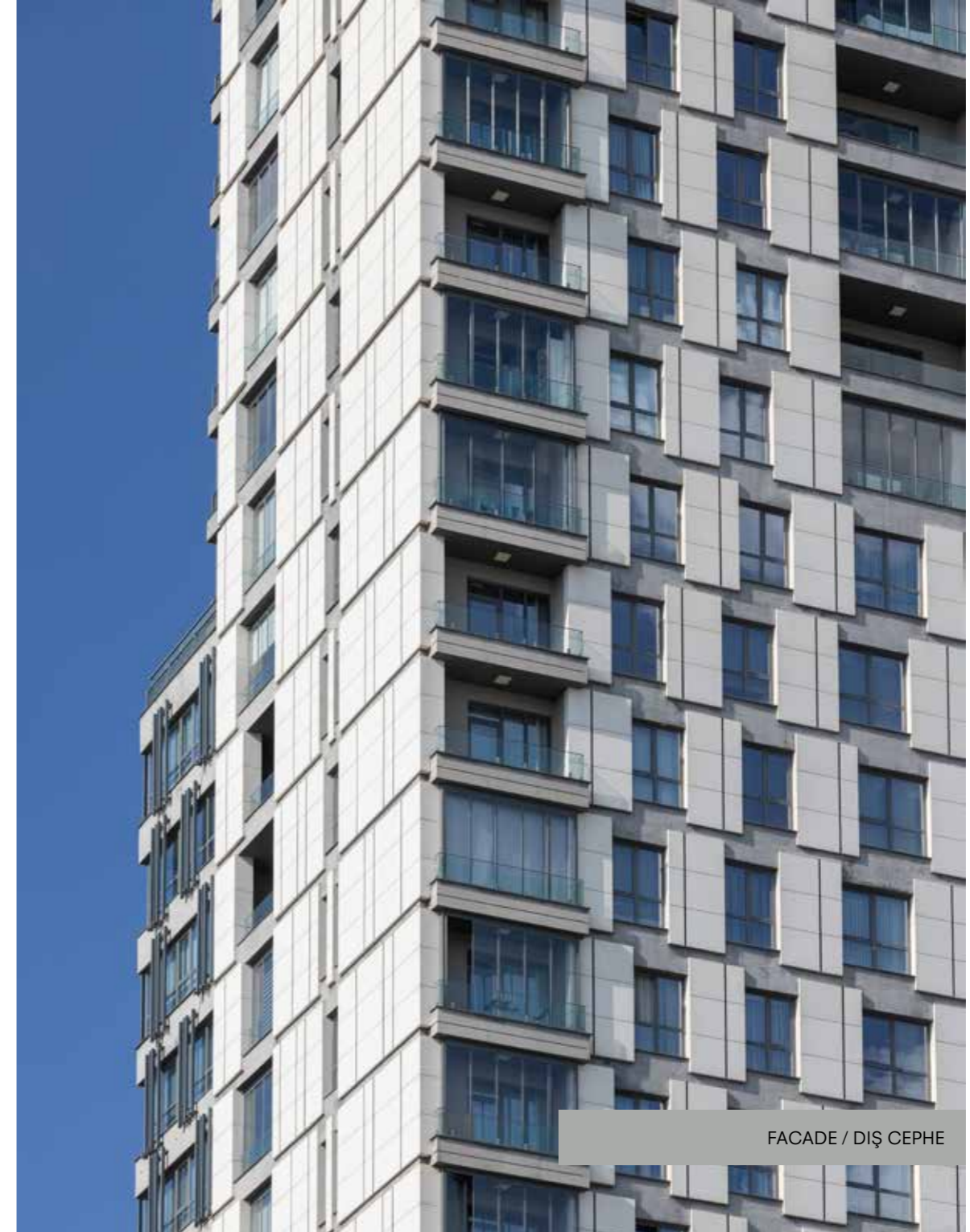

FACADE / DIŞ CEPHE

Elit Manzara / Elit Manzara

Elit Manzara, Ankara — Kalesinterflex Luxury Cement Grey, Innovation Mega White 100x300cm / Hidden Clips System
GÖKHAN AKSOY ARCHITECTS

Elit Manzara, Ankara — Kalesinterflex Luxury Cement Gri, Innovation Mega Beyaz 100x300cm / Gizli Klipsli Sistem
GÖKHAN AKSOY MİMARLIK



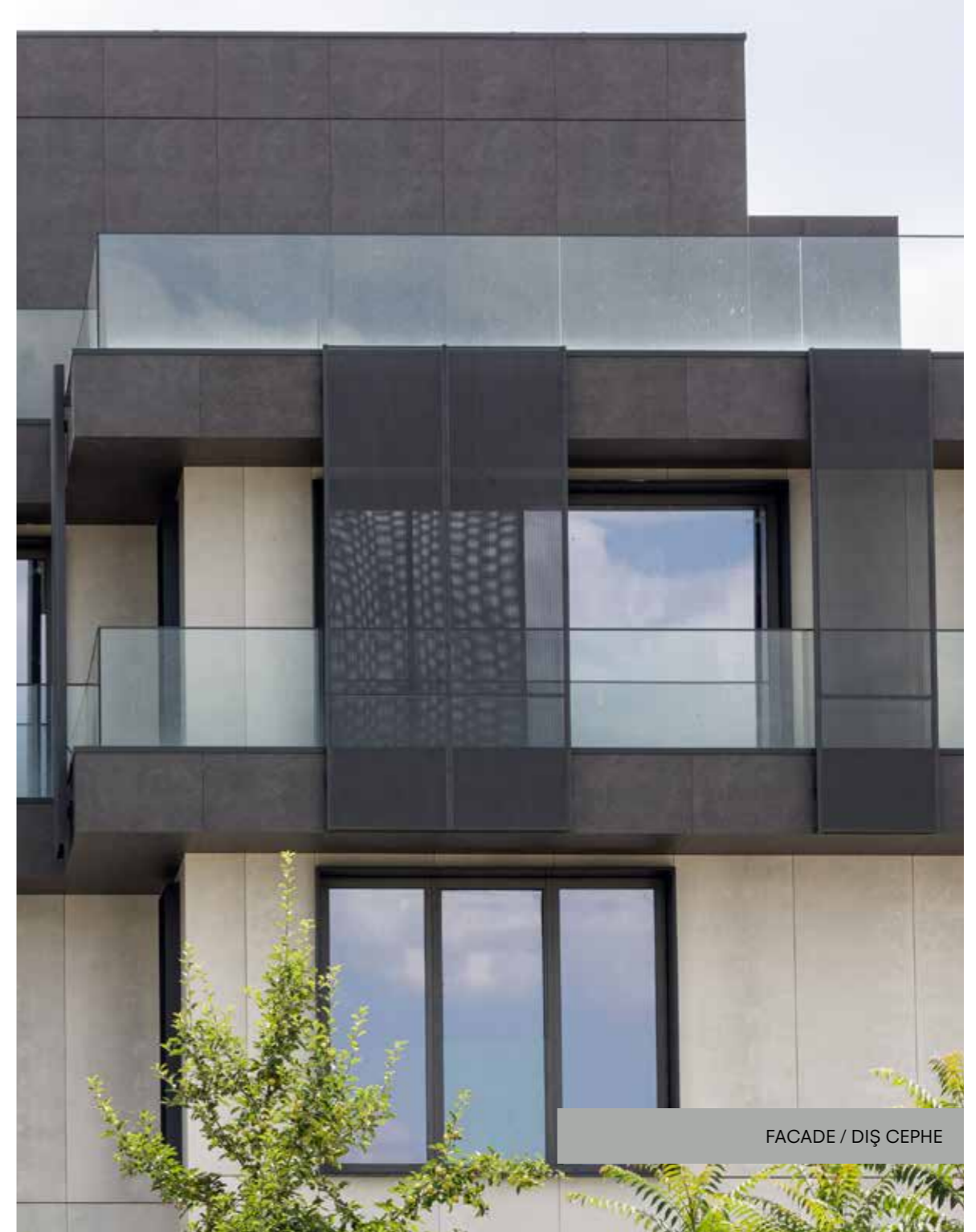

FACADE / DIŞ CEPHE

Fidanlar İnşaat Genel Merkezi Fidanlar Construction Headquarters

Fidanlar İnşaat Genel Merkezi, Ankara — C-Stone Anthracite, Ocean White 120x360cm / Hidden Clips System
AS ARCHITECTS

Fidanlar İnşaat Genel Merkezi, Ankara — C-Stone Antrasit, Ocean White 120x360cm / Gizli Klipsli Sistem
AYŞİN SEVGİ MİMARLIK

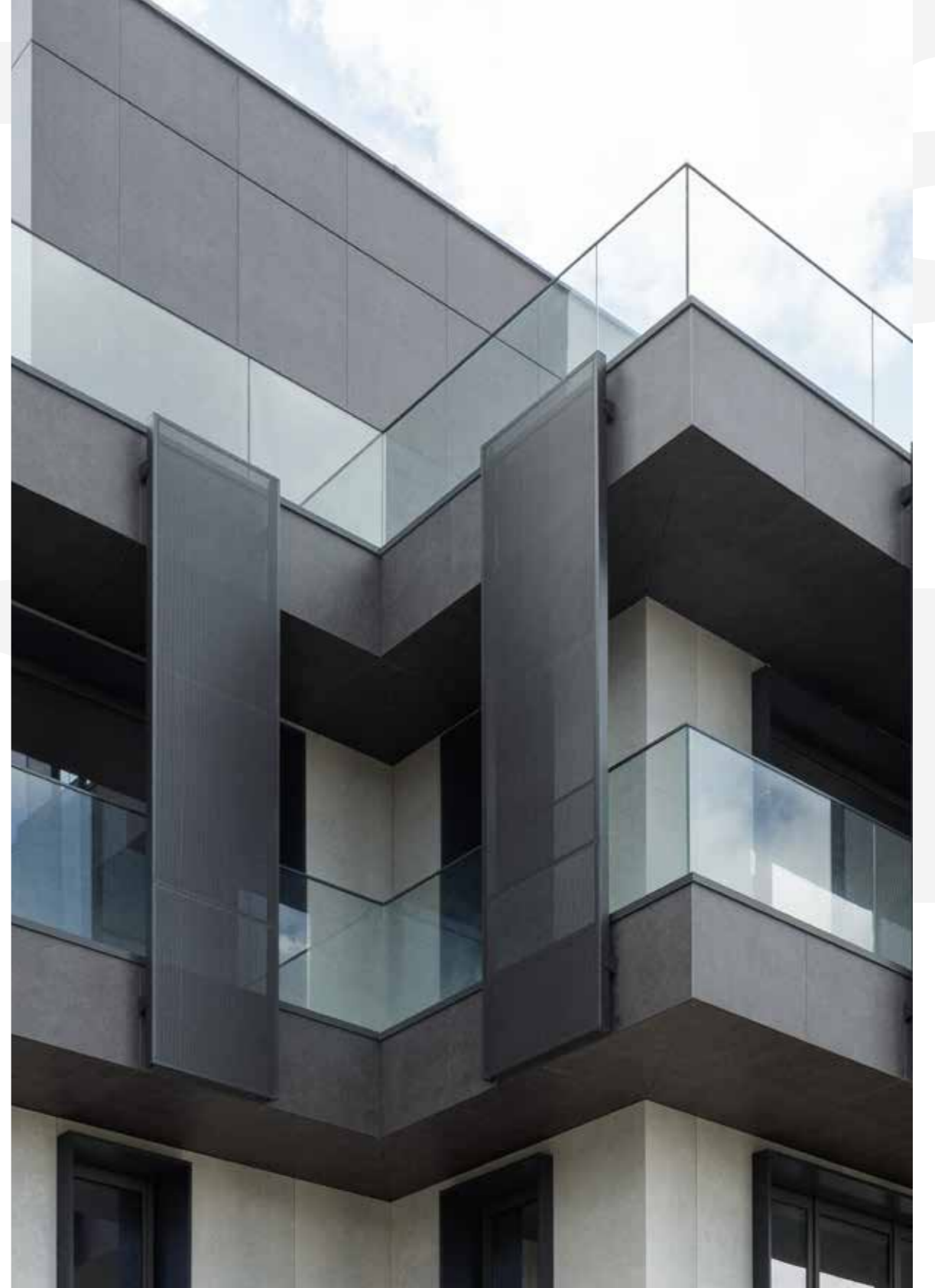



FACADE / DIŐ CEPHE

Imperium / Imperium

Imperium, İstanbul — Luxury Cement Anthracite, C-Stone White 100x300cm and Special Size / Hidden Clips System
ARCHITECT EROL SALIKOĐLU

Imperium, İstanbul — Luxury Cement Antrasit, C-Stone Beyaz 100x300cm ve Özel Ebat / Gizli Klipsli Sistem
MİMAR EROL SALIKOĐLU





FACADE / DIŞ CEPHE

Jandarma Academy / Jandarma Akademi

Jandarma Academy, Ankara — Innovation White, Woodline Cherry 120x360cm / Hidden Clips System
MAVIPERİ ARCHITECTURE

Jandarma Akademi, Ankara — Innovation Beyaz, Woodline Kiraz 120x360cm / Gizli Klipsli Sistem
MAVIPERİ MİMARLIK





FACADE / DIŞ CEPHE

Jandarma Lodging / Jandarma Lojman

Jandarma Lodging, Ankara — Innovation White, Luxury Cement Anthracite 100x300cm / Adhesion System on Aluminum Construction

Jandarma Lojman, Ankara — Innovation Beyaz, Luxury Cement Antrasit 100x300cm / Alüminyum Konstrüksiyon Üzeri Yapıştırma Sistemi



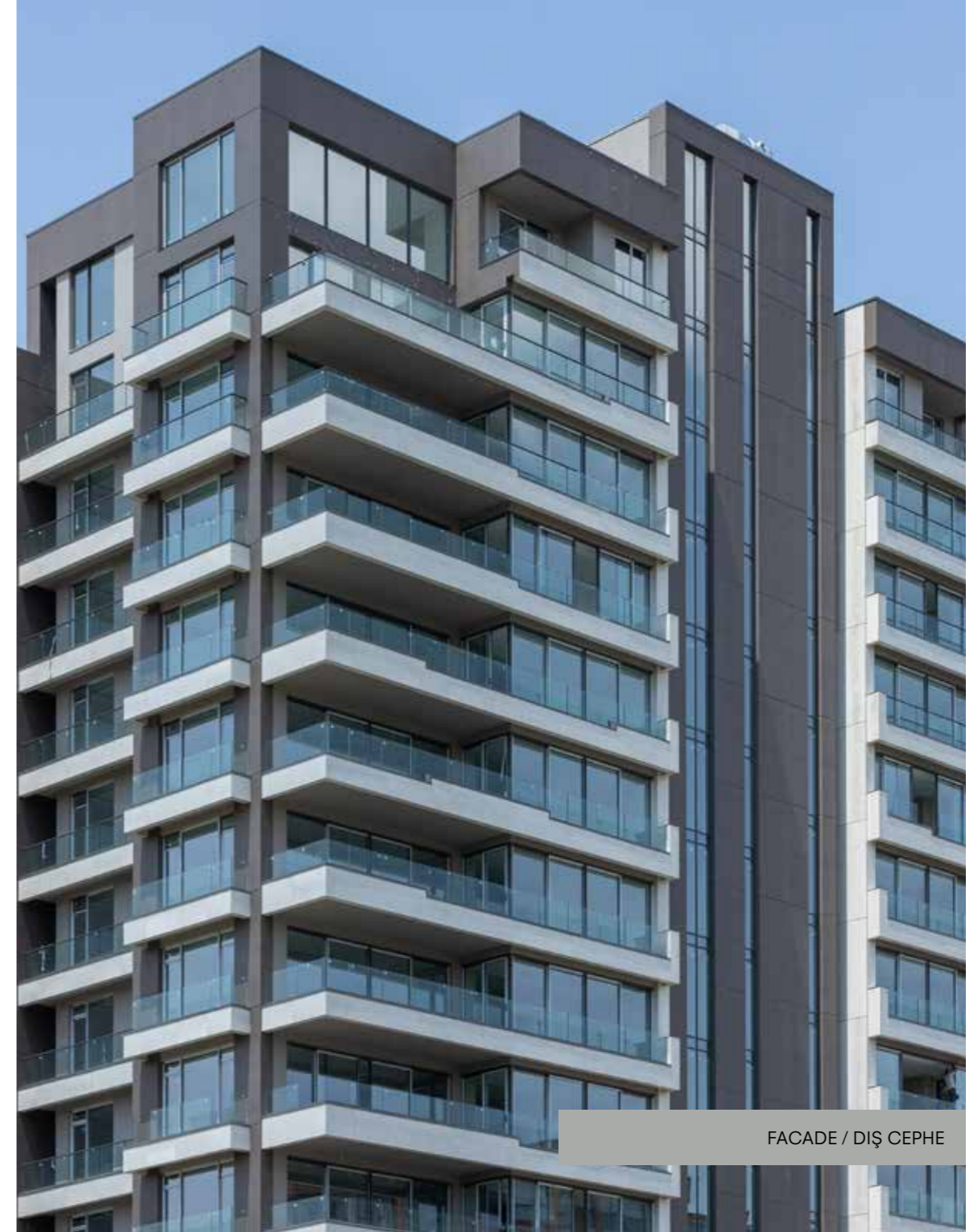

FACADE / DIŞ CEPHE

Magna Epic / Magna Epic

Magna Epic, Ankara — Ocean White, Luxury Cement Mink 120x360cm / Hidden Clips System
ACE ARCHITECTURE

Magna Epic, Ankara — Ocean White, Luxury Cement Vizon 120x360cm / Gizli Klipsli Sistem
ACE MİMARLIK





FACADE / DIŞ CEPHE

Mutlu Koru / Mutlu Koru

Mutlu Koru, Ankara — Kalesinterflex C-Stone Anthracite, Mega White, Oxido Moss, Mega White, Black
100x300cm - 120x360cm / Hidden Clips System
AS ARCHITECTS

Mutlu Koru, Ankara — Kalesinterflex C-Stone Antrasit, Mega Beyaz, Oxido Yosun, Mega Beyaz, Siyah
100x300cm - 120x360cm / Gizli Klipsli Sistem
AYŞİN SEVGİ MİMARLIK

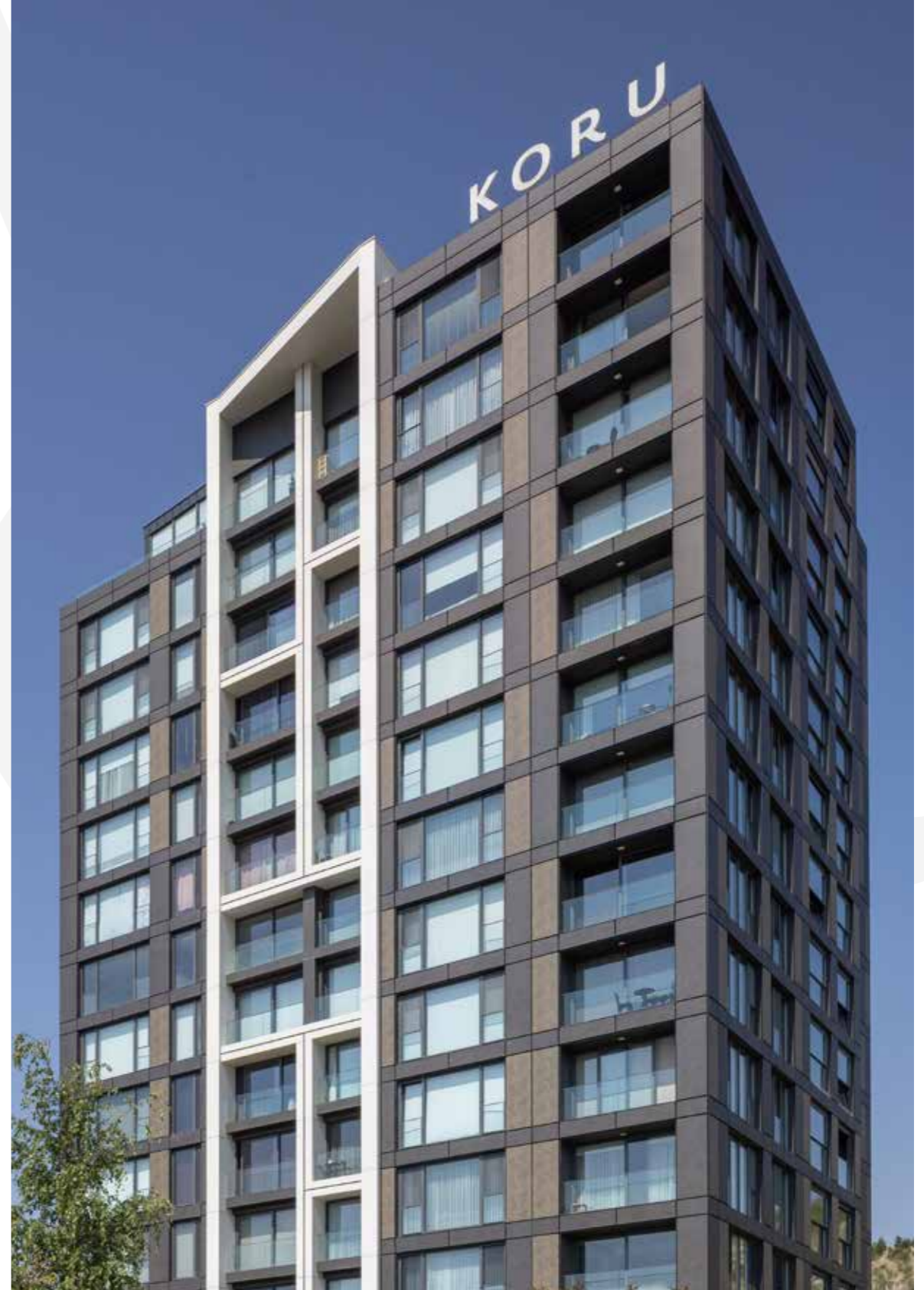
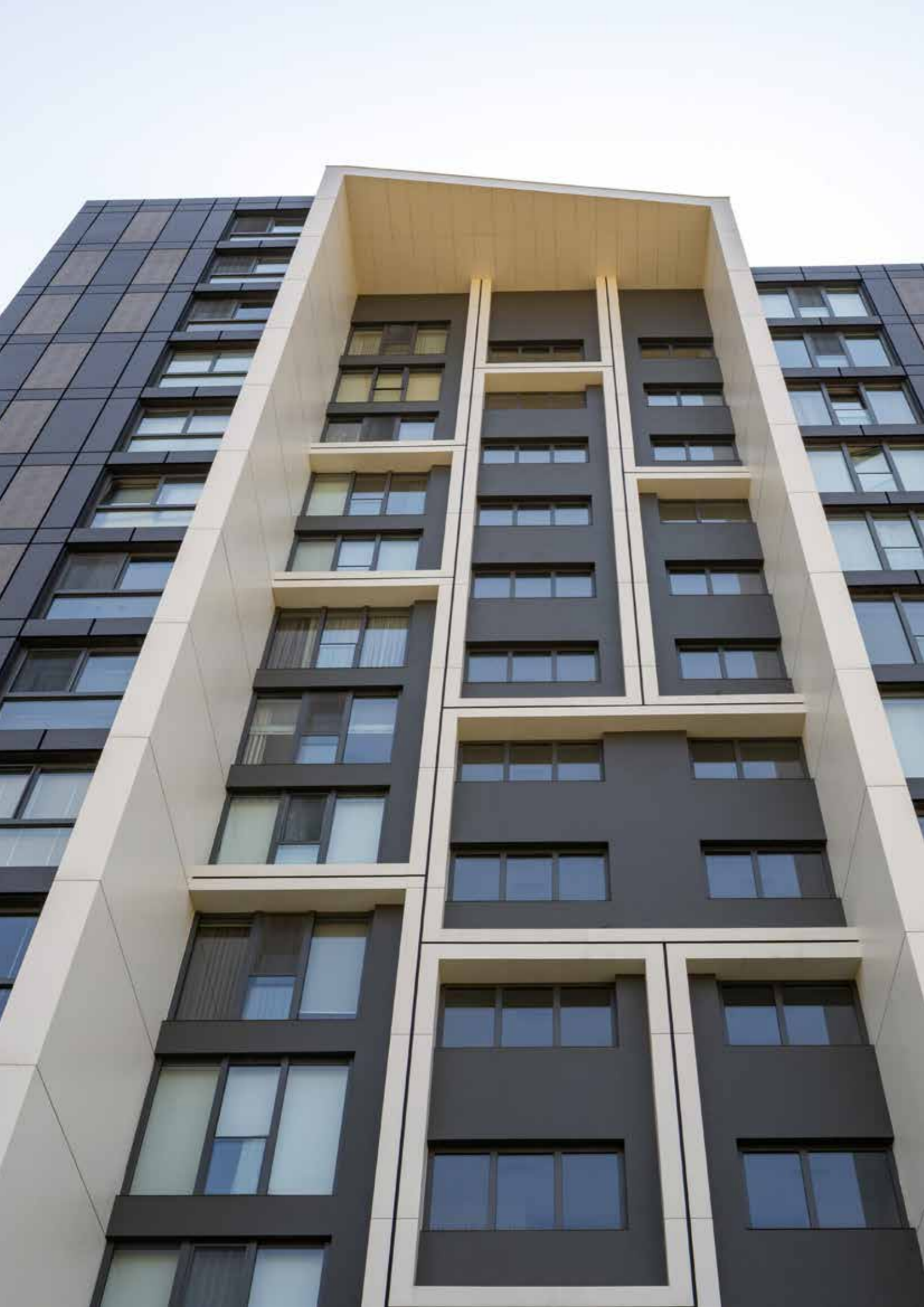



FACADE / DIŞ CEPHE

Neva Garden / Neva Garden

Neva Garden, İstanbul — Kalesinterflex + Porcelain Tile / Innovation Dark Grey, Edilcuoghi Stone Gallery Luserna Silver, Vals White, Uddo Gold 60x120cm, 60x360cm, 20x120cm / Clips System, Hidden Clips System

PUHU PROJECT

Neva Garden, İstanbul — Kalesinterflex + Porselen Karo / Innovation Koyu Gri, Edilcuoghi Stone Gallery Luserna Silver, Vals Beyaz, Uddo Gold 60x120cm, 60x360cm, 20x120cm / Klipsli Sistem, Gizli Klipsli Sistem

PUHU MİMARLIK

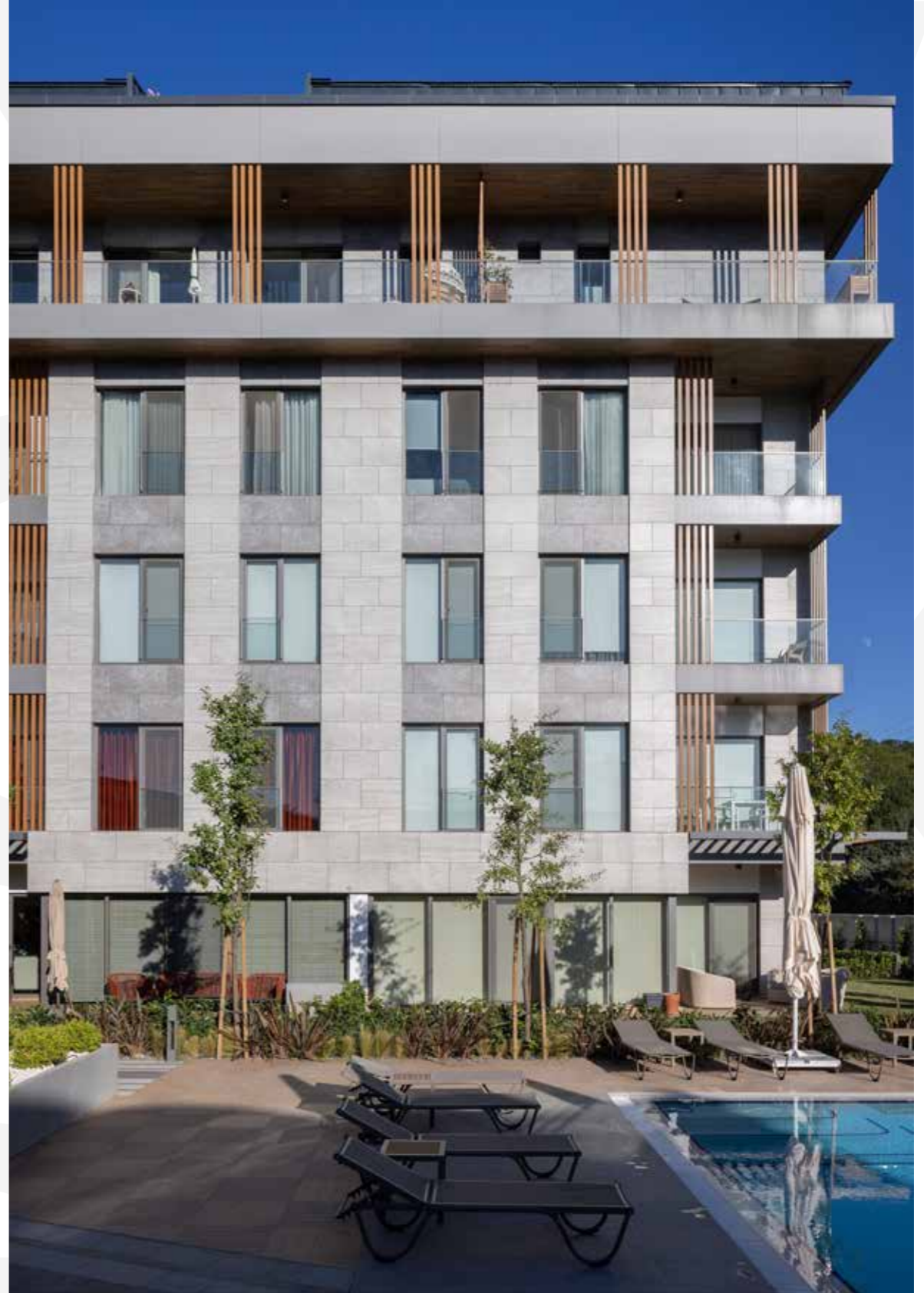



FACADE / DIŞ CEPHE

Neva Suites / Neva Suites

Neva Suites, İstanbul — Natural Stone Leccese Dark Sand, Luxury Cement Mink, C-Stone Anthracite, Woodline Oak
120x360cm, 100x300cm / Hidden Clips System
CM ARCHITECTURE

Neva Suites, İstanbul — Natural Stone Leccese Dark Sand, Luxury Cement Vizon, C-Stone Antrasit, Woodline Meşe
120x360cm, 100x300cm / Gizli Klipsli Sistem
CM MİMARLIK





Park Joven / Park Joven

Park Joven, Ankara — Kalesinterflex + Porcelain Tile, Luxury Cement Anthi, Cotto Cement Almond
100x300cm, 60x120cm / Hidden Clips System, Clips System
AS ARCHITECTS

Park Joven, Ankara — Kalesinterflex + Porselen Seramik, Luxury Cement Anthi, Cotto Cement Almond
100x300cm, 60x120cm / Gizli Klipsli Sistem, Klipsli Sistem
AYŞİN SEVGİ MİMARLIK





FACADE / DIŐ CEPHE

Suadiye Kent / Suadiye Kent

Suadiye Kent, İstanbul — Kalesinterflex K-Greige 100x300cm
CİVAOĞLU ARCHITECTURE

Suadiye Kent, İstanbul — Kalesinterflex K-Greige 100x300cm
CİVAOĞLU MİMARLIK

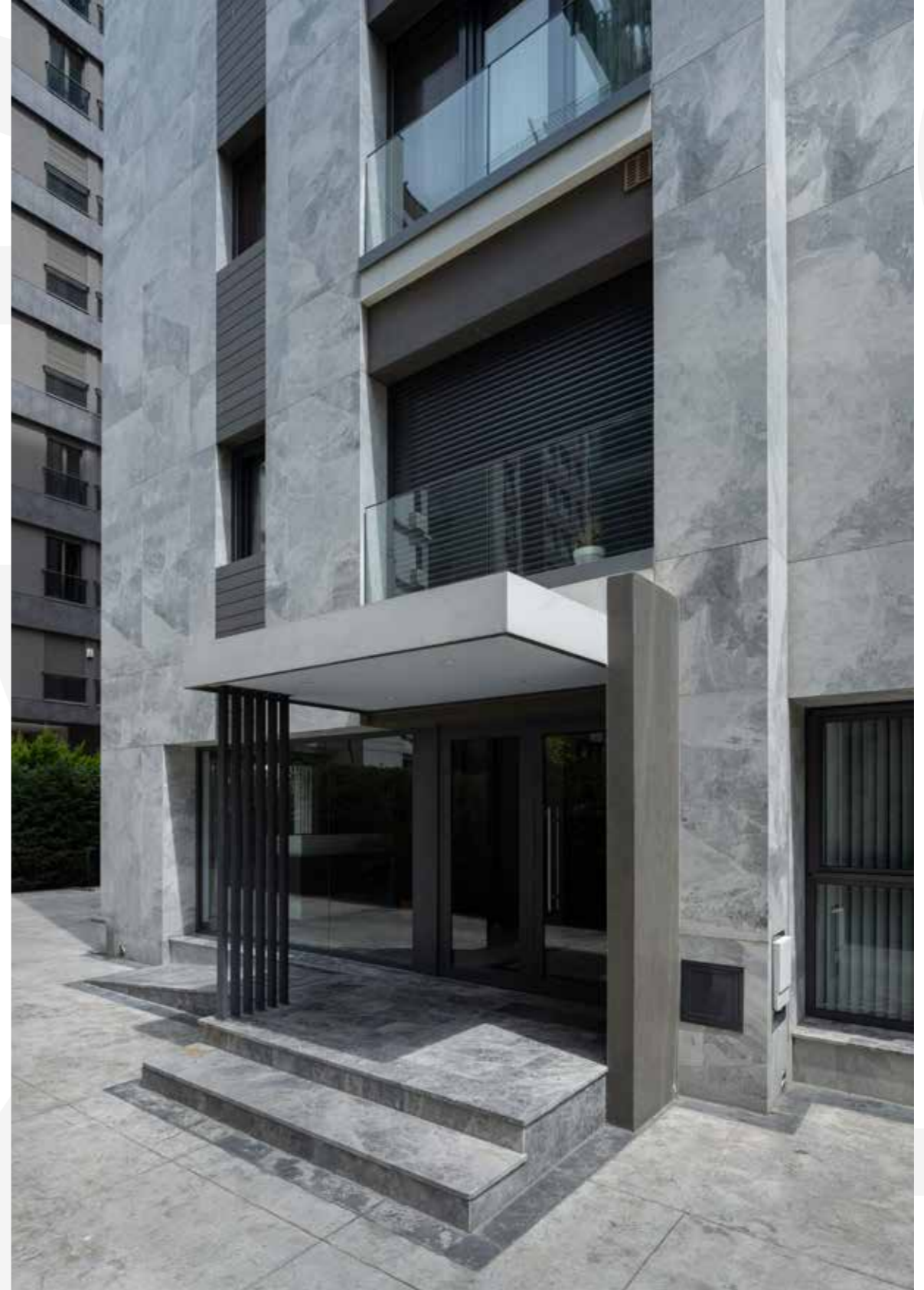

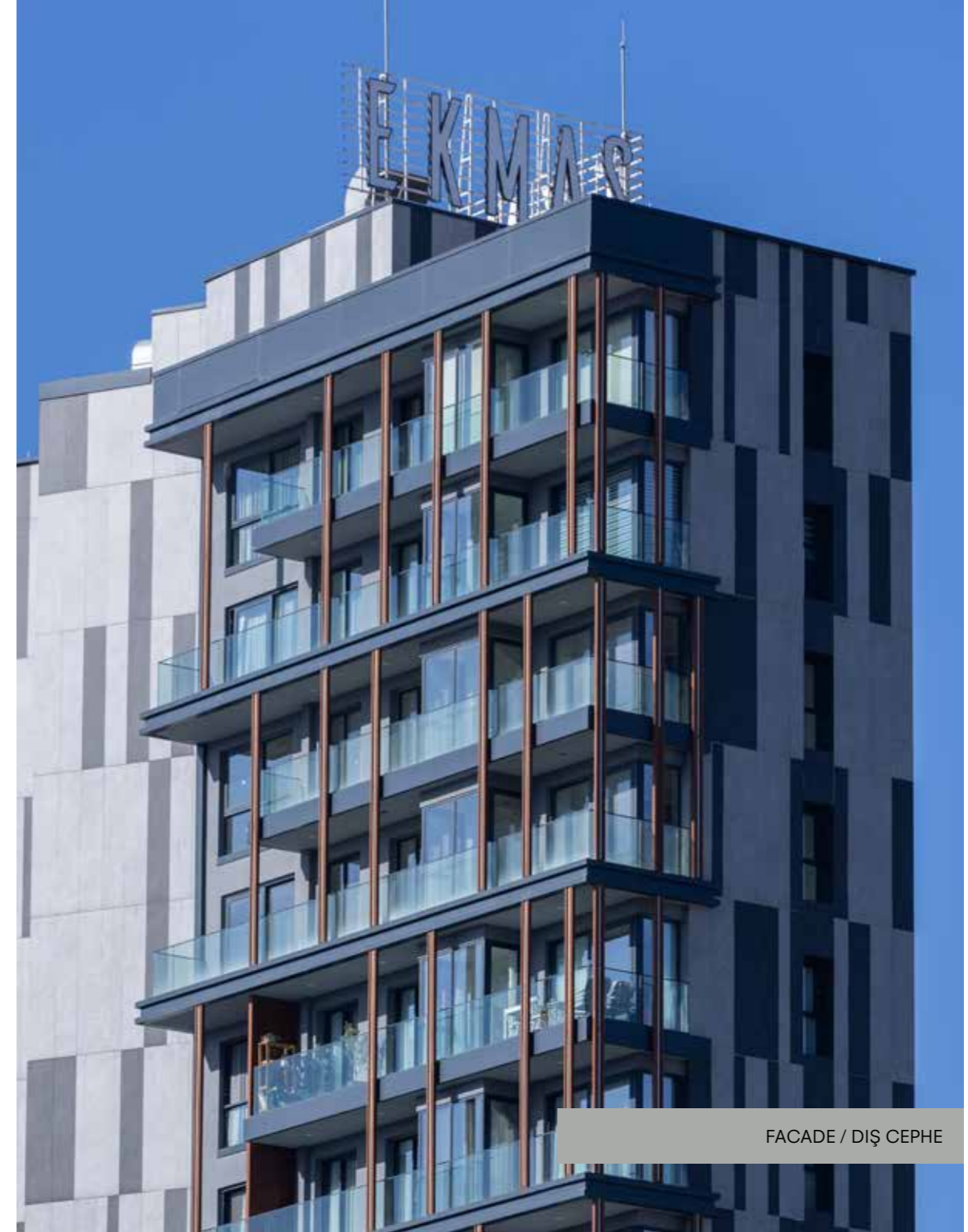

FACADE / DIŐ CEPHE

Ekmas Maviőehir / Ekmas Maviőehir

Ekmas Maviőehir, İzmir— Kalesinterflex Metallic Anthracite, Factory Grige 120x360cm and Special Size / Hidden Clips System
DEMİRCE NORMS ARCHITECTURE

Ekmas Maviőehir, İzmir— Kalesinterflex Metalik Antrasit, Factory Grige 120x360cm ve Őzel Ebat / Gizli Klipsli Sistem
DEMİRCE NORMS MİMARLIK

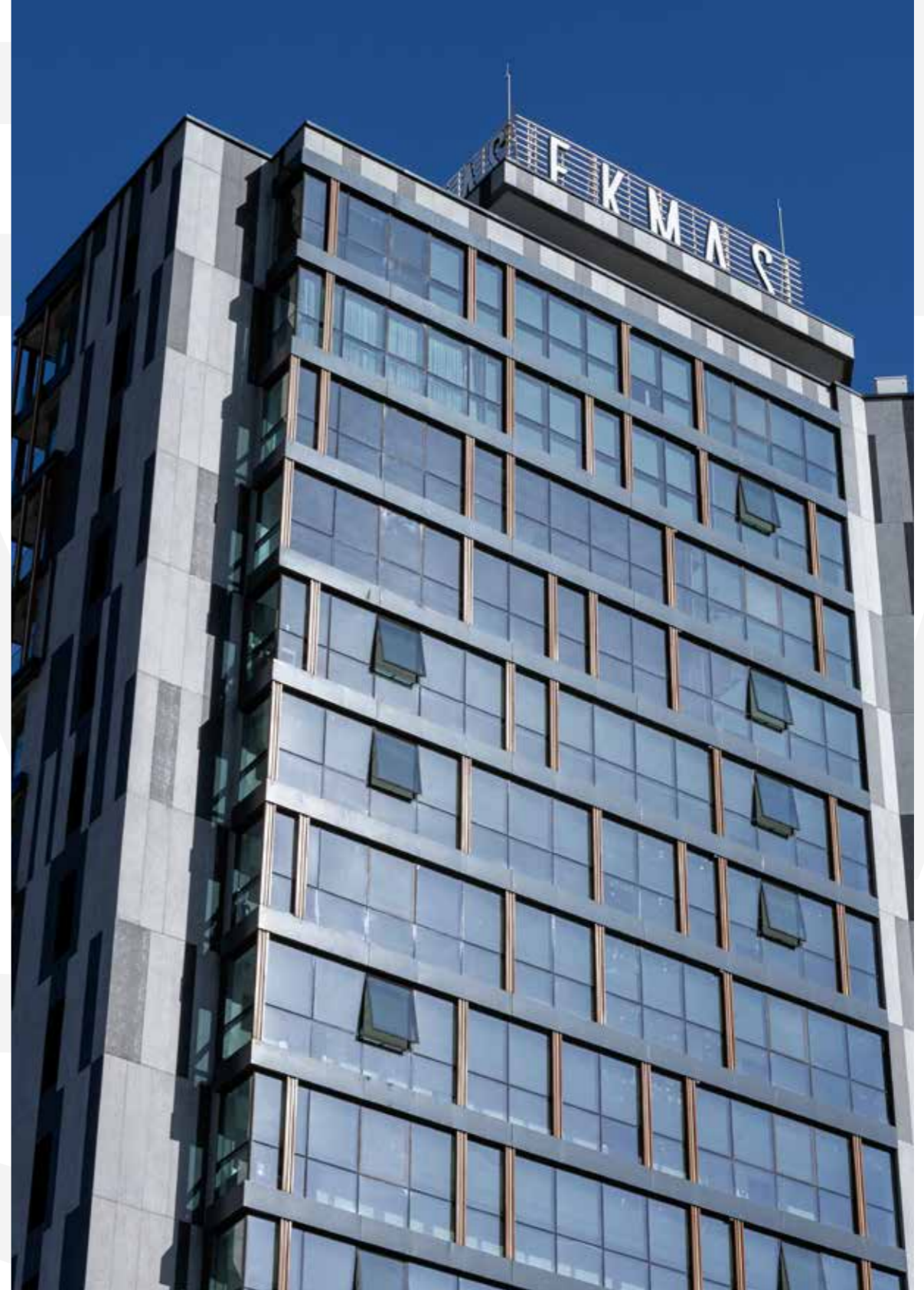
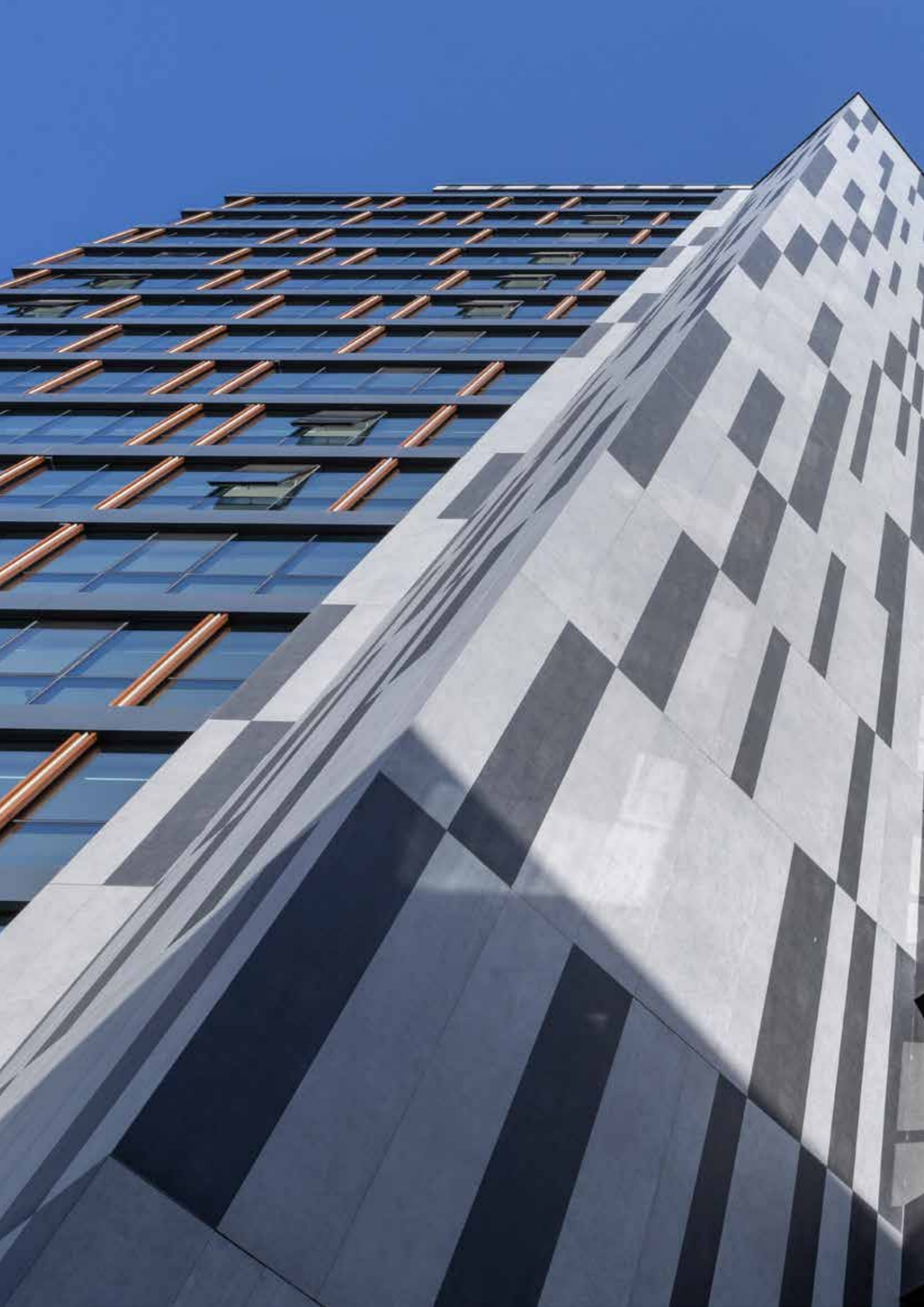



FACADE / DIŞ CEPHE

Çeşme Kün Yapı Villas / Çeşme Kün Yapı Villaları

Çeşme Kün Yapı Villas, İzmir— Kalesinterflex Metallic Anthracite 100x300cm / Adhesion System on Construction

Çeşme Kün Yapı Villaları, İzmir— Kalesinterflex Metaik Antrasit 100x300cm / Konstrüksiyon Yapıştırma Sistem

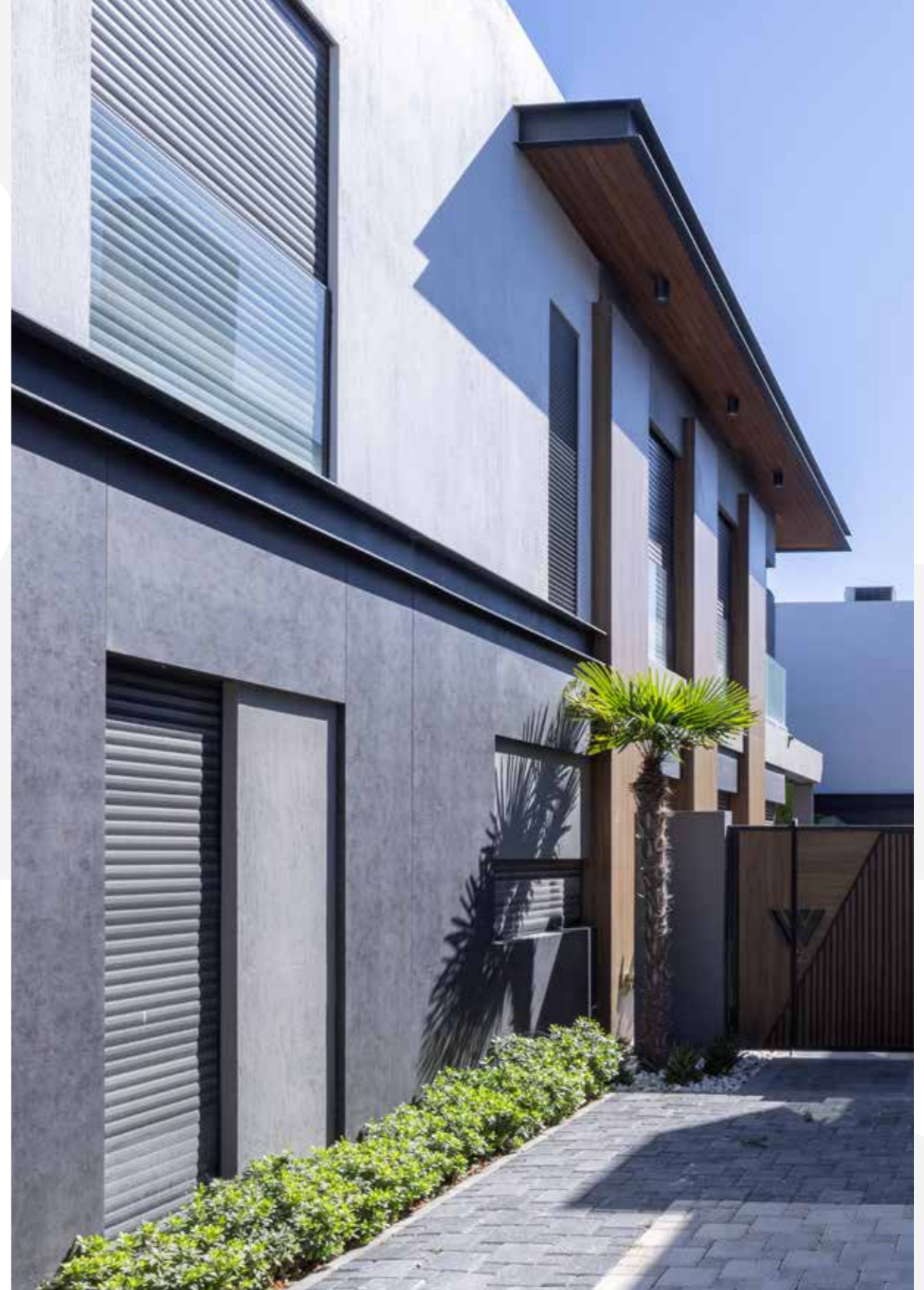



FACADE / DİŞ CEPHE

İzmir Medicana Hospital / İzmir Medicana Hastanesi

İzmir Medicana Hospital, İzmir— Kalesinterflex C-Stone Grey, C-Stone Anthracite, Innovation Extra White 100x300cm / Hidden Clips System
RASYONEL ARCHITECTS

İzmir Medicana Hospital, İzmir— Kalesinterflex C-Stone Gri, C-Stone Antrasit, Innovation Extra Beyaz 100x300cm / Gizli Klipsli Sistem
RASYONEL MİMARLIK

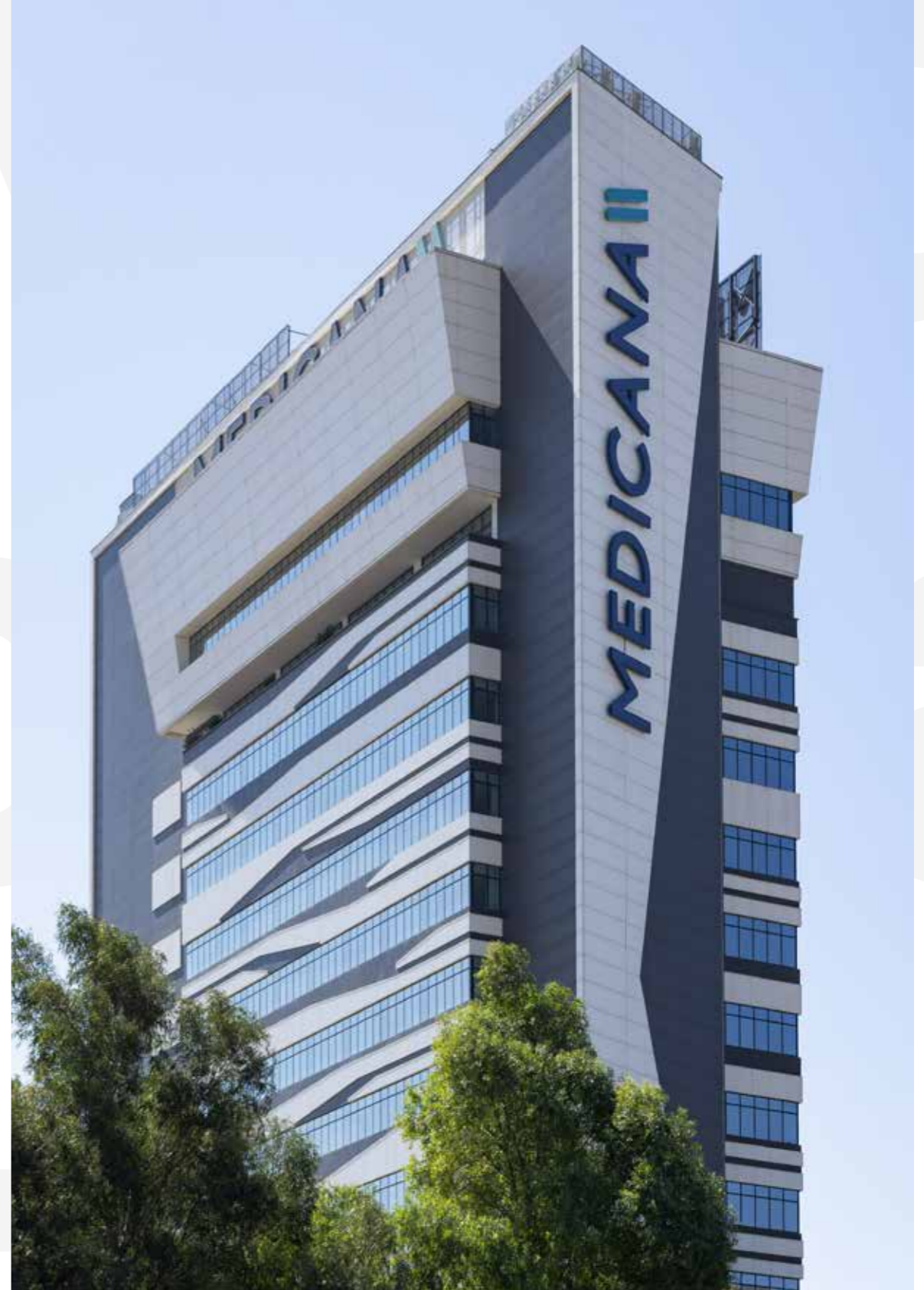



FACADE / CEPHE

SK Games / SK Games

SK Games, Ankara — Kalesinterflex Uptown Light 100x300cm, Kalesinterflex Uptown Dark / Adhesion System on Aluminum Construction, Hidden Clips System

A ARCHITECTURAL DESIGN

SK Games, Ankara — Kalesinterflex Uptown Light 100x300cm, Kalesinterflex Uptown Dark / Alüminyum Konstrüksiyon Üzeri Yapıştırma Sistem, Gizli Klips Sistem

A TASARIM MİMARLIK

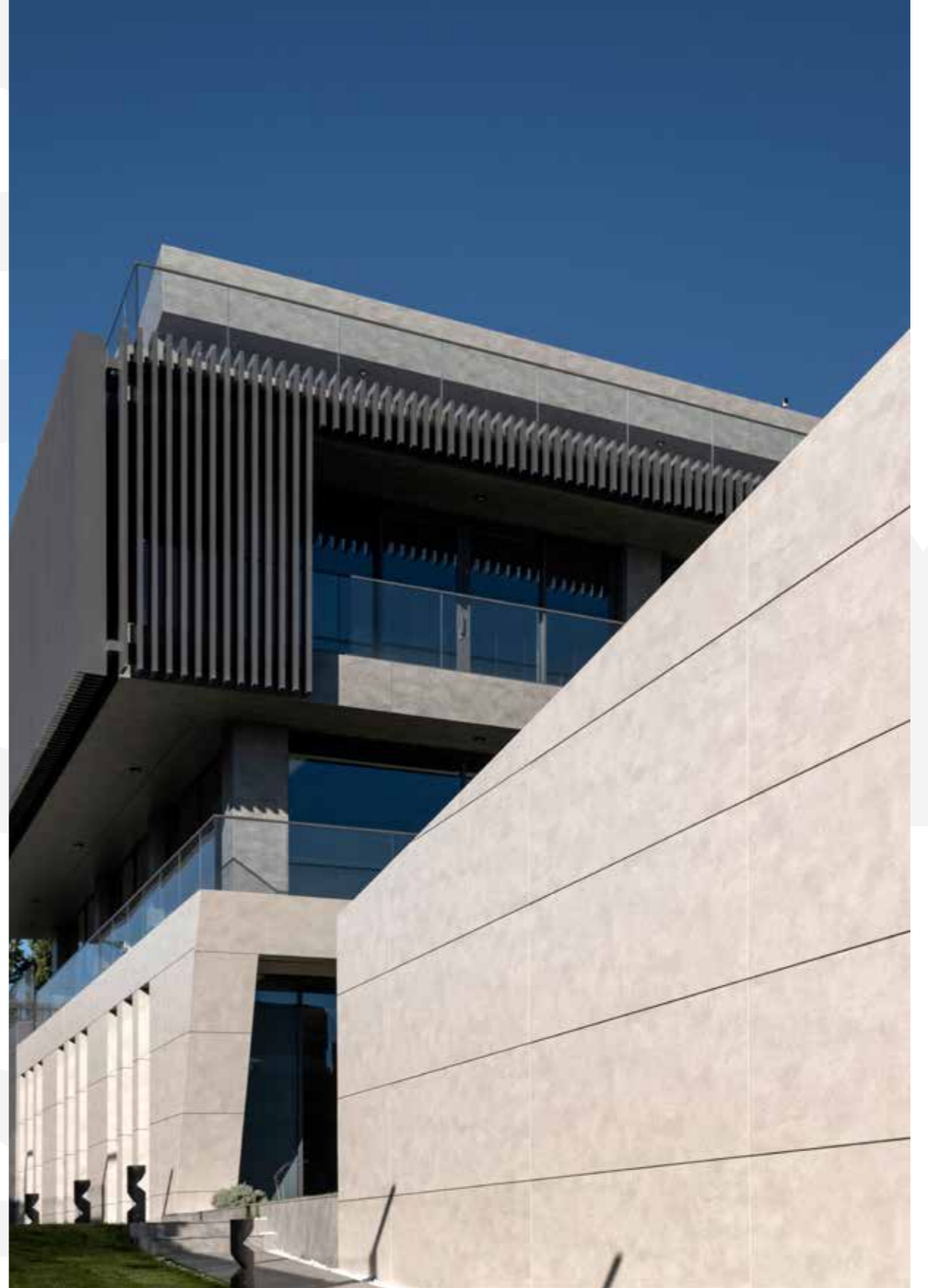



FACADE / CEPHE

Emlak Başkent Konutları / Emlak Başkent Konutları

Başkent Konutları, Ankara — Innovation Extra White, Innovation Saffron, Innovation Blue, Innovation Dark Grey, C-Stone Beige, Luxury Cement Anthracite, Luxury Cement Sand, Luxury Cement Grey, Oxido Moss, Oxido White, Woodline Oak 100x300cm

Kalesinterflex 120x360cm / Hidden Clips System

SPDO ARCHITECTS

Başkent Konutları, Ankara — Innovation Extra Beyaz, Innovation Safran, Innovation Mavi, Innovation Koyu Gri, C-Stone Bej, Luxury Cement Antrasit, Luxury Cement Kum, Luxury Cement Gri, Oxido Yosun, Oxido Beyaz, Woodline Meşe 100x300cm

Kalesinterflex 120x360cm / Gizli Klips Sistem

SPDO MİMARLIK

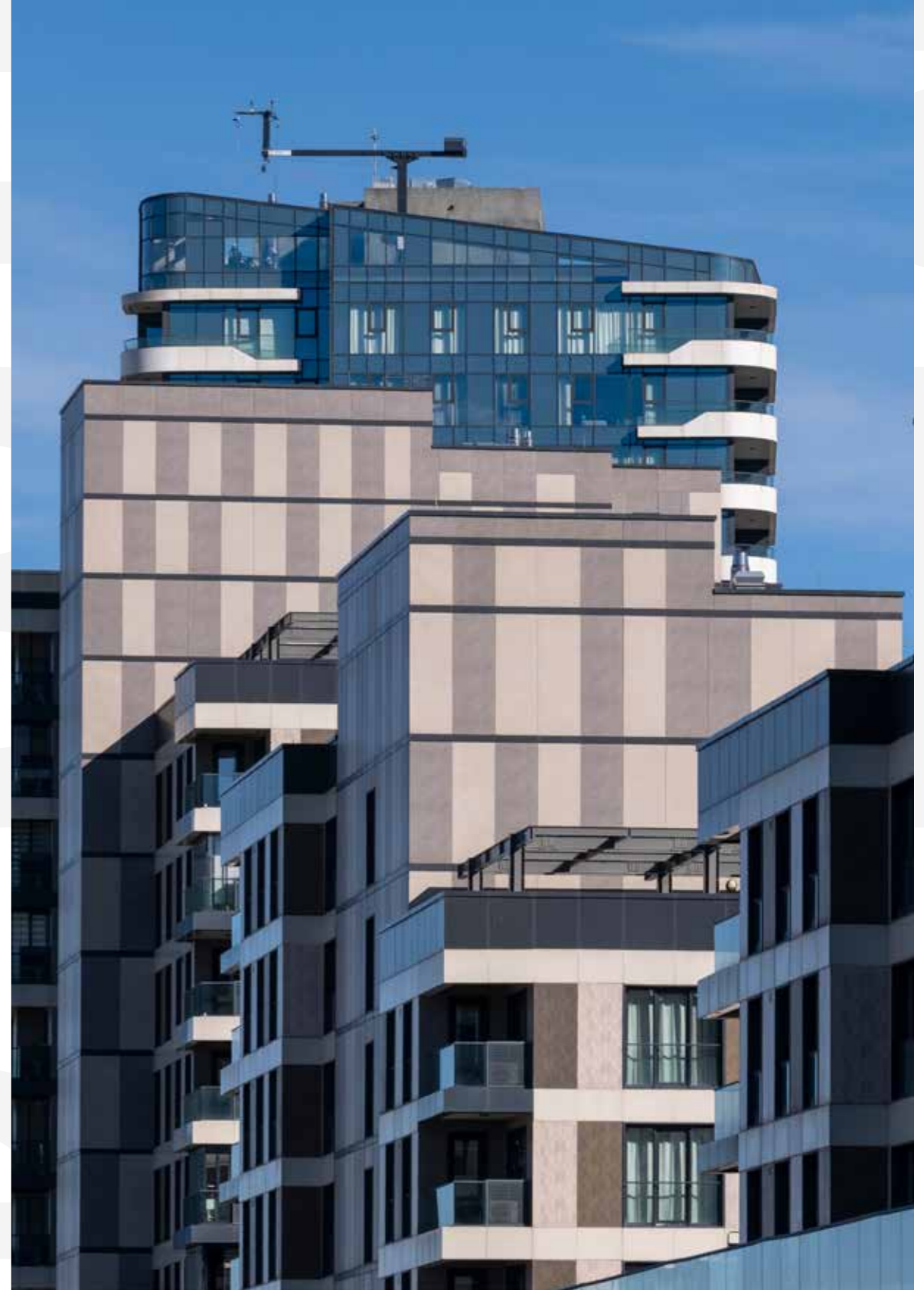
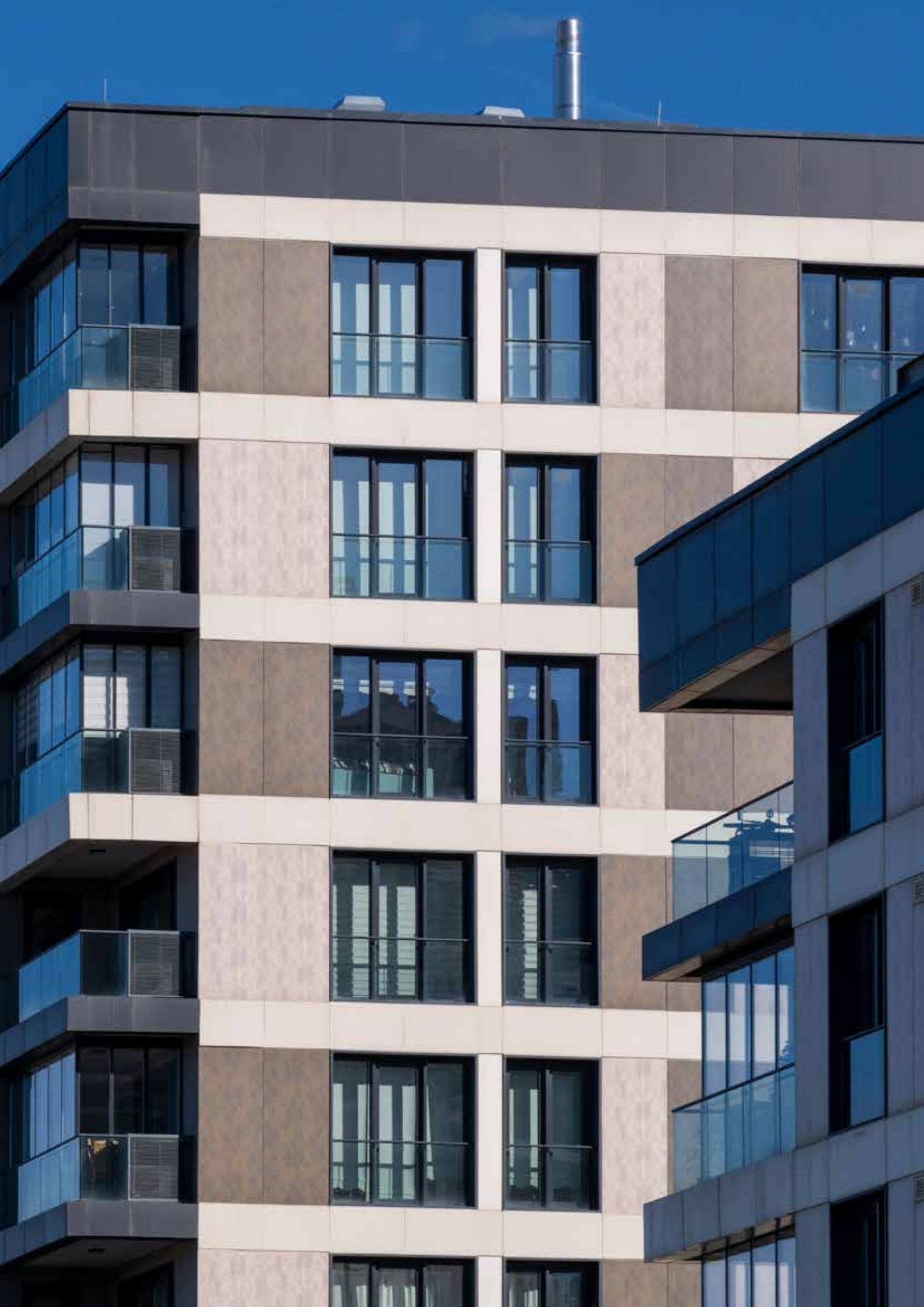



Pruva 34 / Pruva 34

Pruva 34, İstanbul — Kalesinterflex C-Stone White, C-Stone Brown 100x300cm / Special Panel System
ALPAR ARCHITECT

Pruva 34, İstanbul — Kalesinterflex C-Stone White, C-Stone Kahve 100x300cm / Özel Panel Sistem
ALPAR ARCHITECT





Central Bank / Merkez Bankası

Central Bank, Antalya — Innovation White 2.0 / 100x300cm / Adhesion System on Aluminum Construction
TANART ARCHITECT

Merkez Bankası, Antalya — Innovation Beyaz 2.0 / 100x300cm / Alüminyum Konstrüksiyon Üzeri Yapıştırma Sistem
TANART MİMARLIK

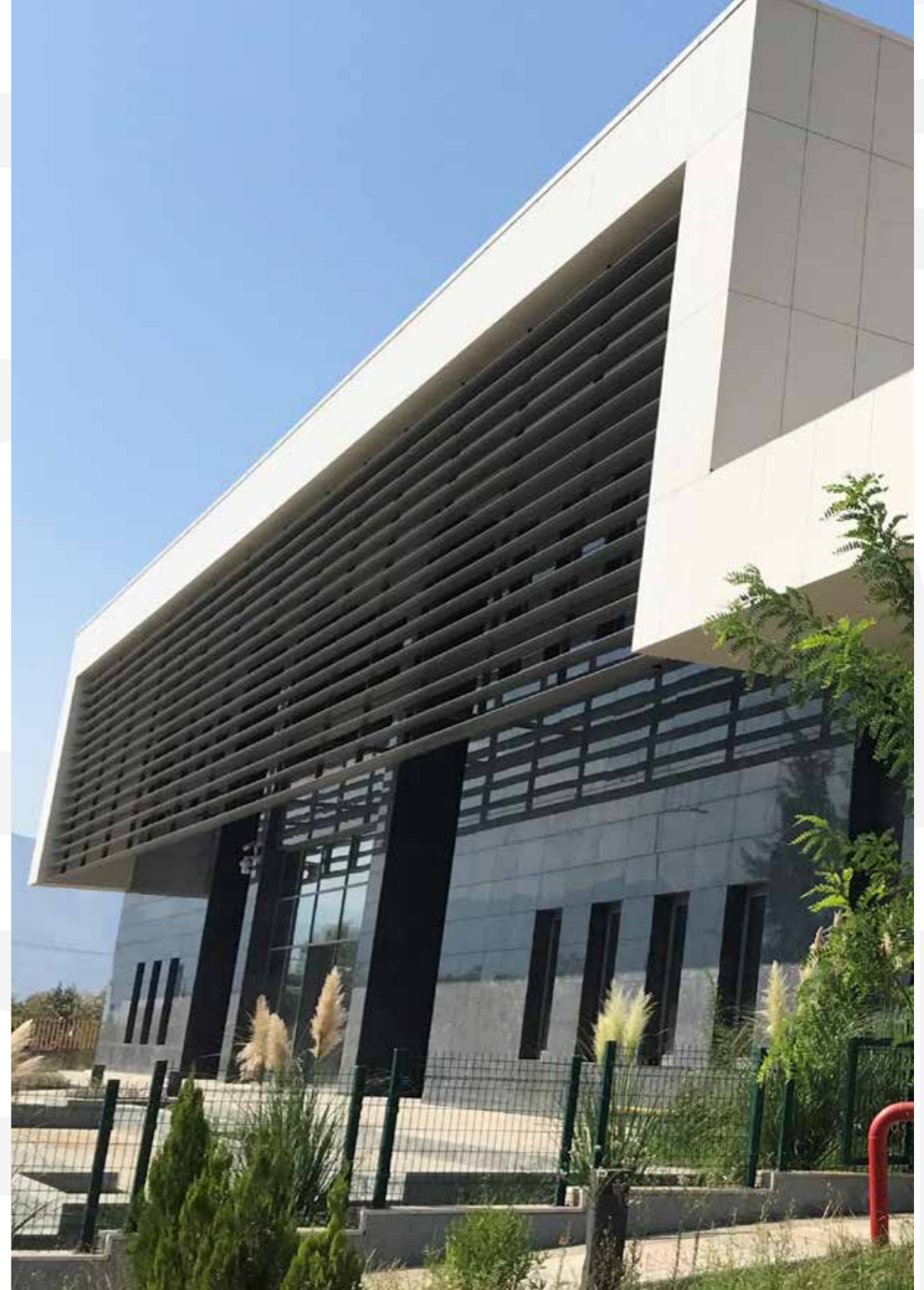



FACADE / CEPHE

Armada Residence / Armada Residence

Armada Residence, Antalya — Luxury Cement Mink, Innovation White 2.0 / 100x300cm
YILMAZHAN ARCHITECT

Armada Residence, Antalya — Luxury Cement Vizon, Innovation Beyaz 2.0 / 100x300cm
YILMAZHAN ARCHITECT

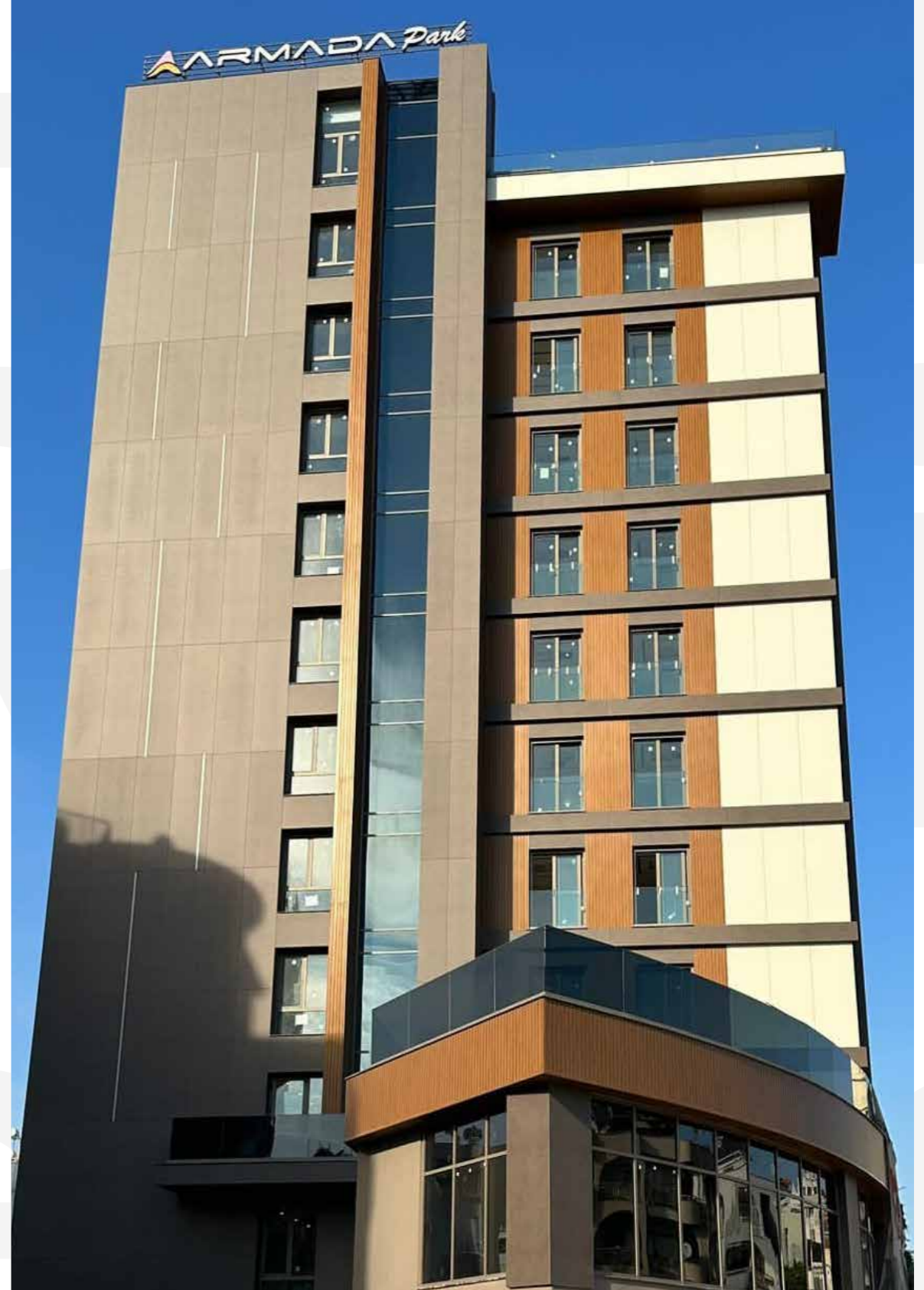



Worldwide Projects

Yurt Dışı Projeler



FACADE / CEPHE

Atomy Headquarter / Atomy Headquarter

Atomy Headquarter, South Korea — Kalesinterflex Innovation Extra White 100x300cm
L'EAU DESIGN LAB

Atomy Headquarter, Güney Kore — Kalesinterflex Innovation Extra Beyaz 100x300cm
L'EAU DESIGN LAB

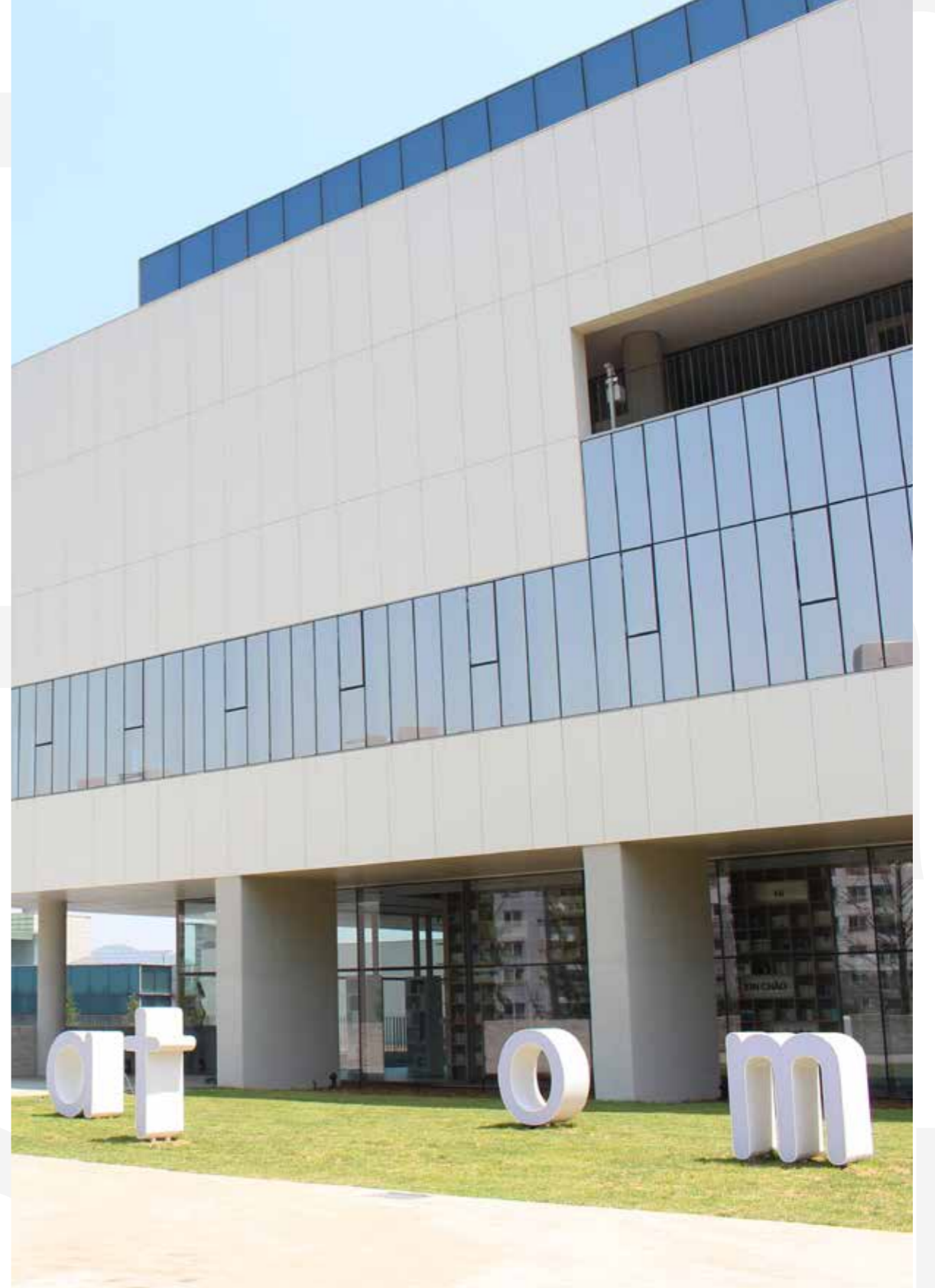



FACADE / CEPHE

36.Order- Sejong City M-Bridge Project / 36.Order- Sejong City M-Bridge Project

Sejong City M-Bridge, South Korea — Kalesinterflex Innovation White 2.0, Luxury Cement Anthracite Grey 100x300cm
DABICHI ARCHITECTS

Sejong City M-Bridge, South Korea — Kalesinterflex Innovation Beyaz 2.0, Luxury Cement Antrasit Gri 100x300cm
DABICHI ARCHITECTS



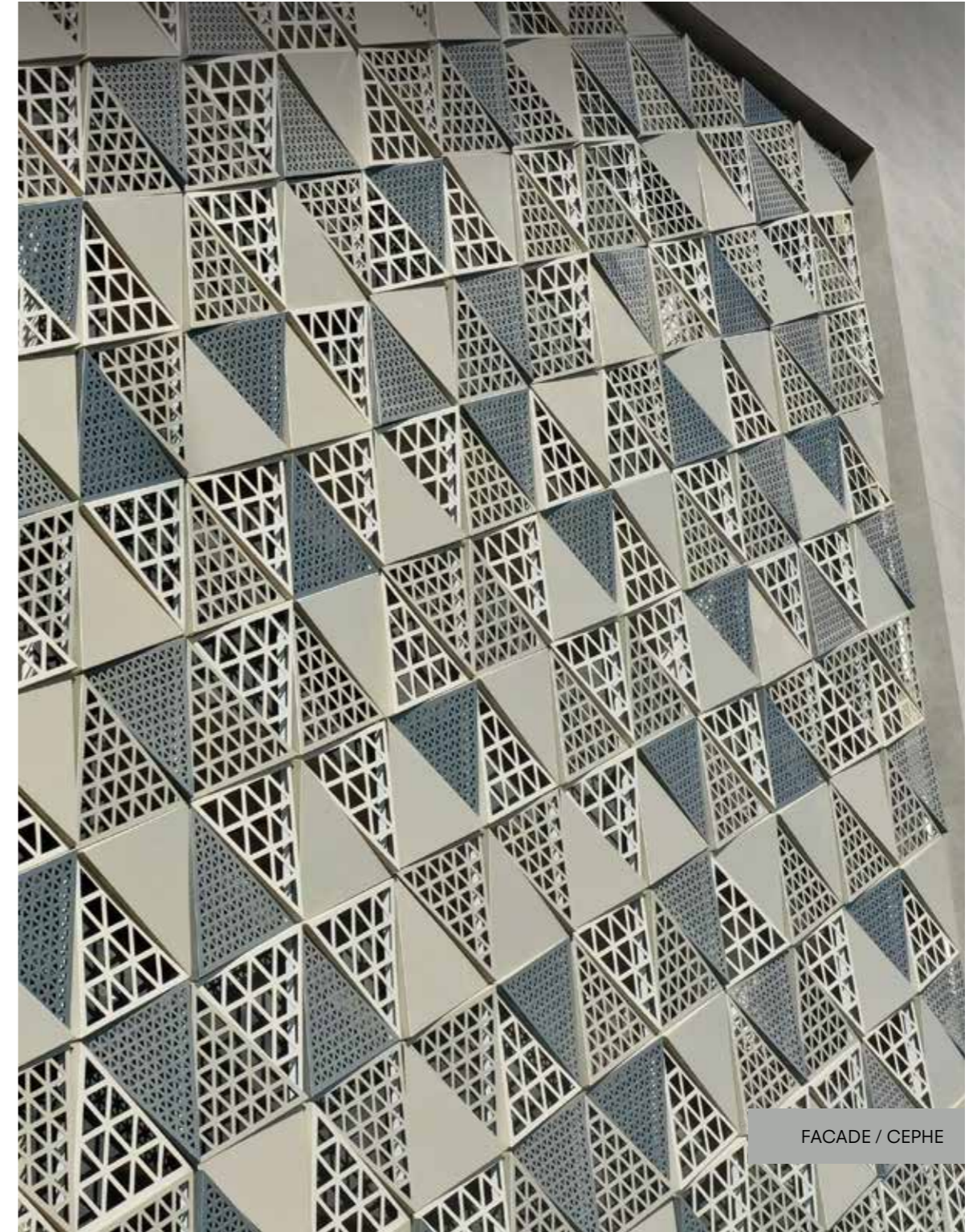
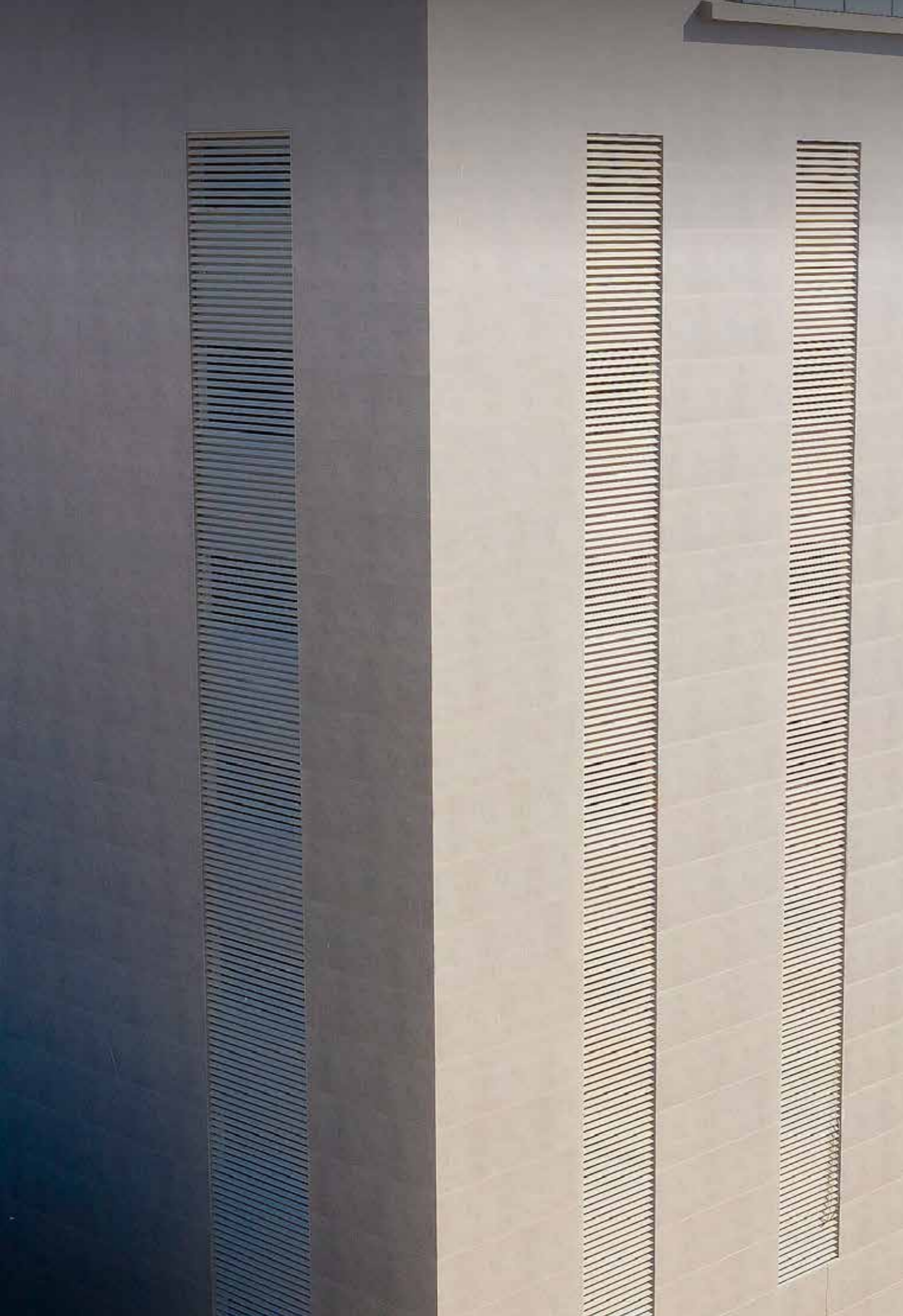

FACADE / CEPHE

Marina-Karachi / Marina-Karachi

Marina-Karachi, Pakistan — Kalesinterflex Luxury Cement Grey 100x300cm / Hidden Clips System

Marina-Karachi, Pakistan — Kalesinterflex Luxury Cement Gri 100x300cm / Gizli Klipsli Sistem

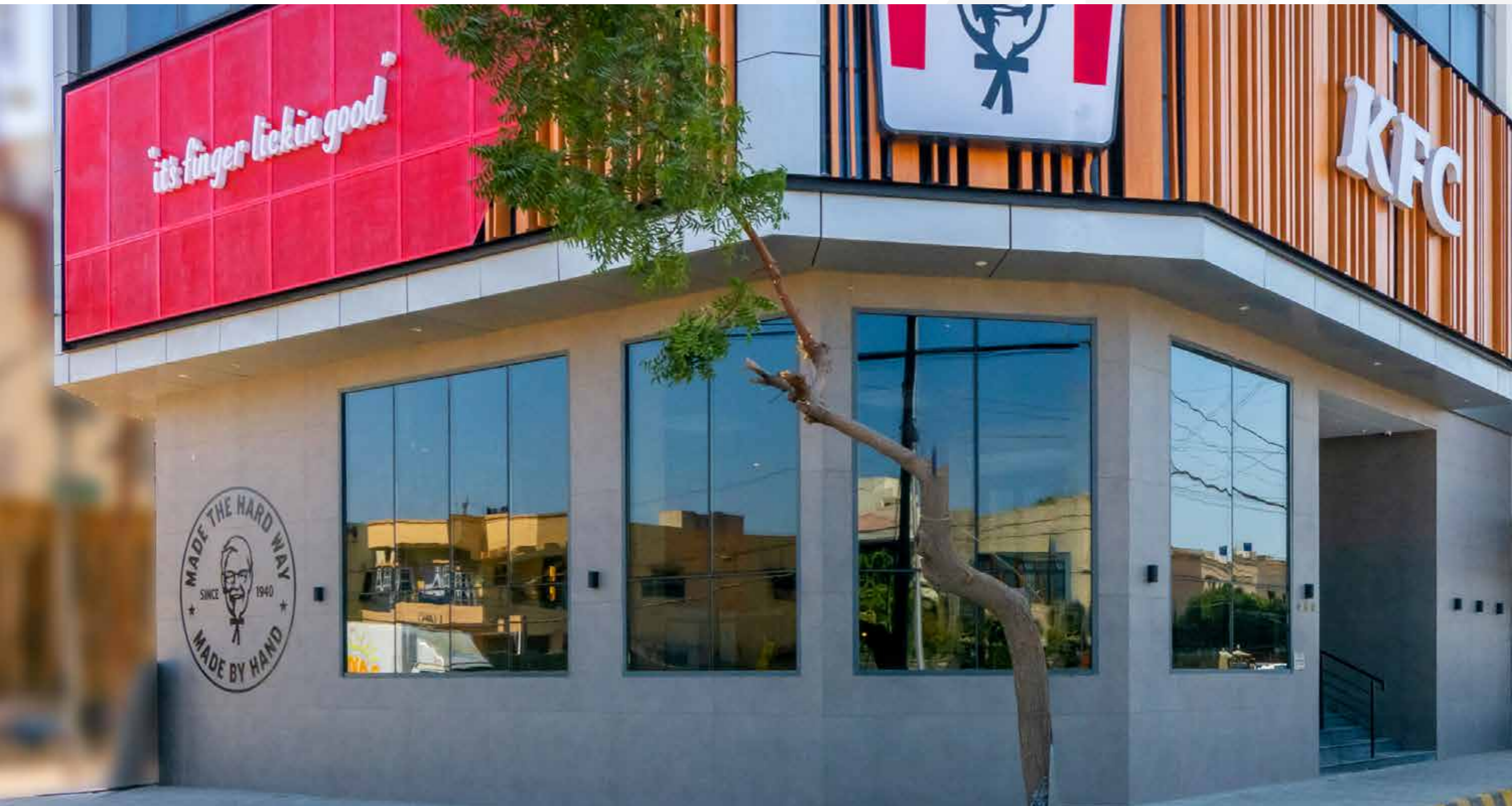

KFC-Karachi / KFC-Karachi

KFC-Karachi, Pakistan — Kalesinterflex 100x300cm Luxury Cement Grey, Palladium Copper / Hidden Clips System

KFC-Karachi, Pakistan — Kalesinterflex 100x300cm Luxury Cement Gri, Palladium Copper / Gizli Klipsli Sistem



FACADE / CEPHE

Uzbekistan Kale Gallery / Özbekistan Kale Galeri

Tashkent, Uzbekistan — Kalesinterflex Luxury Cement Anthi, Innovation Orange 100x300

Taşkent, Özbekistan — Kalesinterflex Luxury Cement Anthi, Innovation Turuncu 100x300





Referinta Sarmi Constanta / Referinta Sarmi Constanta

Raferina Sarmi Constanta, Romania — Kalesinterflex Terazzo, Innovation Black, Innovation White, Innovation Blue, Luxury Cement Grey, Limestone 100x300cm,120x360cm / Invisible System and Indoor
ARHISKIN SRL-ROW STUDIO

Raferina Sarmi Constanta, Romanya — Kalesinterflex Terazzo, Innovation Siyah, Innovation Beyaz, Innovation Mavi, Luxury Cement Gri, Limestone 100x300cm,120x360cm / Gizli Klipsli Sistem ve İç Mekan
ARHISKIN SRL-ROW STUDIO



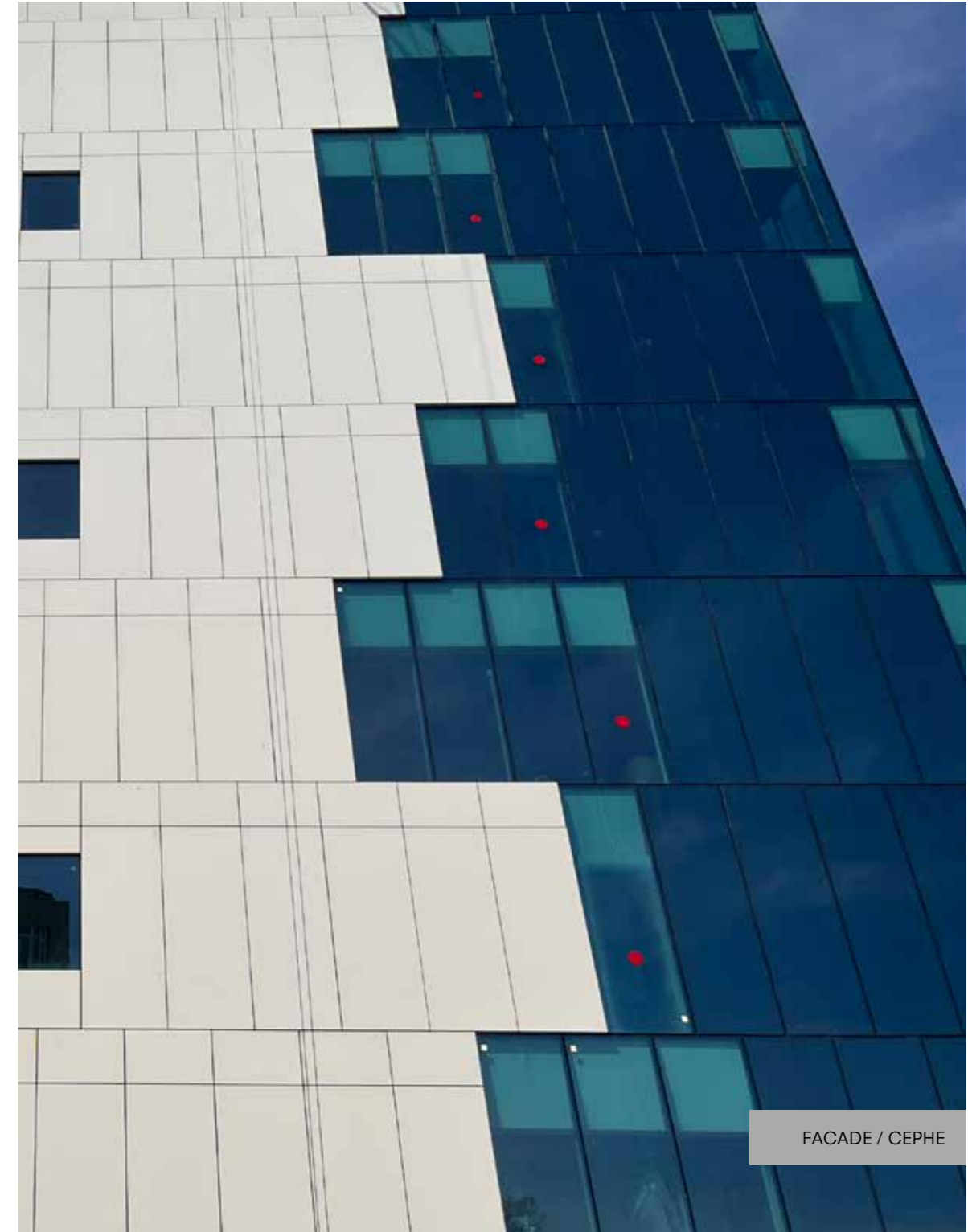

FACADE / CEPHE

Craiova Q-Fort / Craiova Q-Fort

Craiova Q-Fort, Romania — Kalesinterflex Innovation Extra White 120x360cm / Hidden Clips System
ARHISKIN SRL-Q-FORT

Craiova Q-Fort, Romanya — Kalesinterflex Innovation Extra Beyaz 120x360cm / Gizli Klipsli Sistem
ARHISKIN SRL-Q-FORT



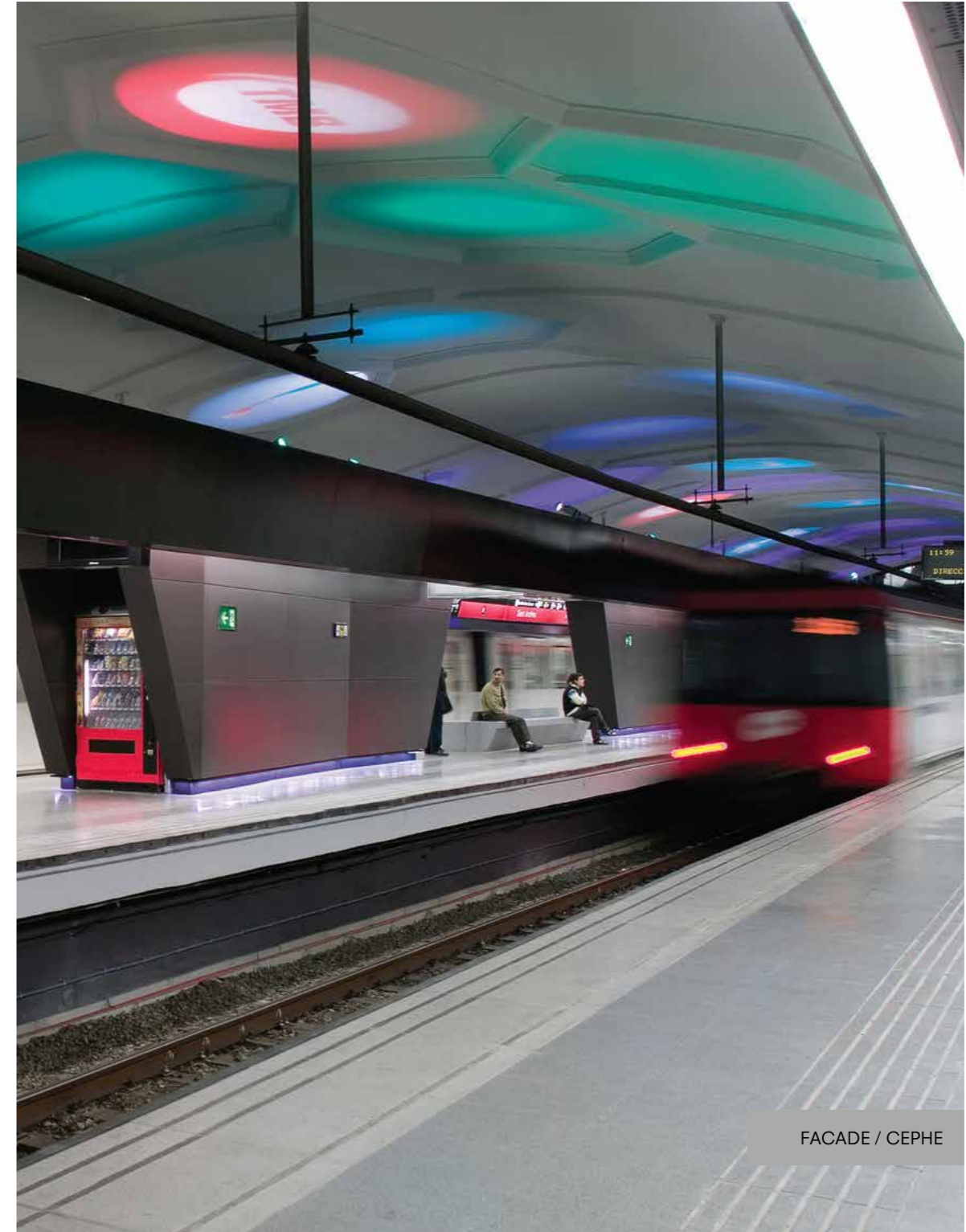

FACADE / CEPHE

Barcelona Metro Station, Spain
Barcelona Metro İstasyonu, İspanya



FACADE / CEPHE

Barcelona Metro

Technology and Products

Teknoloji ve Ürünler

DECOTECH

The Technology Of Art

Sanatın Teknolojisi



DECOTECH technology, which stands out due to the application of special materials to the surfaces and their separation from flatly printed products, and matte or glossy materials bearing the name of granilla create a striking relief effect on the products.

Reliefs, which can be applied synchronously or independently according to different design needs and wishes, are often preferred in decorative and positive spaces.

Yüzeyle özel malzemelerin uygulanması ve düz baskılı ürünlerden ayrıştırılmasıyla öne çıkan DECOTECH teknolojsi, granilya adını taşıyan mat veya parlak malzemeler, ürünlerde çarpıcı bir kabartma etkisi oluşturur.

Farklı tasarım ihtiyaçlarına ve isteklere göre senkronize veya bağımsız olarak uygulanabilen kabartmalar, dekoratif ve pozitif mekanlarda sıklıkla tercih edilir.



BODYTECH

The Technology Of Consistency

Devamlılığın Teknolojisi



BODYTECH technology, which refers to the use of salt-pepper-mas in traditional porcelain production, is constituted from finely ground mas mixtures containing homogeneous stone textures and different color shades on the surface of the products. Thanks to the special method that carries the visual effect on the surface of the product to the product structure, each edge and each cut point of the product offers a harmonious and holistic appearance with the surface.

Geleneksel porselen üretimindeki tuz biber masse kullanımını ifade eden BODYTECH teknolojsi, ürünlerin yüzeyinde homojen taş dokusu ve farklı renk tonlarını içeren ince öğütülmüş masse karışımlarıyla oluşturulur. Ürünün yüzeyindeki görsel etkiyi ürün bünyesine taşıyan özel yöntemle, ürünün her bir kenarı ve kesilen her noktası, yüzeyle uyumlu ve bütünsel bir görünüm sunar.

FLOWTECH

The Technology Of Eternity

Sonsuzluğun Teknolojisi



FLOWTECH, used as a pattern tracking technology, ensures the progression of the pattern between the panels of marble-look products in particular. It creates a more impressive ambiance in wall applications in spaces. Some marble products were designed using this method. However, during the production phase, the products are produced in a combination. Practitioners should make the right choice during the covering to capture this flow. Thus, the aesthetic and design potential of the space is maximized.

Desen takip teknolojisi olarak kullanılan FLOWTECH, özellikle mermer görümlü ürünlerin panelleri arasındaki desenin devamlılığını sağlar. Mekanlardaki duvar kullanımlarında daha etkileyici bir atmosfer oluşturur. Bazı mermer ürünleri bu yöntemle tasarlanmıştır, ancak üretim aşamasında ürünler karma şekilde üretilir. Bu akışı yakalamak için döşeme sırasında uygulayıcıların doğru seçim yapması gerekmektedir. Böylece mekanın estetik ve tasarım potansiyeli en üst düzeye çıkar.



GLOWTECH

The Technology Of Sparkle

Işıltının Teknolojisi



GLOWTECH, used as a glitter/bright luminescence technology, refers to the effect caused by the glare of micro pieces on the surface of glossy products. This special effect gives the products a more exclusive and eye-catching glow by distinguishing them from standard glossy ones. While it is described as the reflection of the natural mineral glow in some marbles on the ceramic technology, an aesthetic and elegant shine is obtained in the spaces.

Simli/parlak ışıltılar teknolojisi olarak kullanılan GLOWTECH, parlak ürünlerde yüzeydeki mikro parçaların parlamasıyla oluşan etkiyi tanımlar. Bu özel etki, ürünleri standart parlaklardan ayırarak daha özel ve göz alıcı bir ışıltıya kavuşturur. Bazı mermerlerde bulunan doğal mineral ışıltılarının seramik teknolojisine yansımış hali olarak da nitelendirilirken, mekanlarda estetik ve zarif bir parlaklık elde edilir.

OPENBOOK

The Technology Of Symmetry

Simetri Teknolojisi



OPENBOOK, used as a correspondent pattern technology, enables one module to come face to face with the other module and create a unique pattern, especially in marble-look products. This special design distinguishes both modules as A and B with different codes while allowing small pattern shifts of 1-2 cm between them. Thanks to this method, aesthetic and visual diversity is achieved in spaces, and the integrity of the design is preserved.

Karşılıklı desen teknolojisi olarak kullanılan OPENBOOK, özellikle mermer görümlü ürünlerde, bir modülün diğer modül ile yüz yüze gelerek özgün bir desen oluşturmasını sağlar. Bu özel tasarım, modüller arasında 1-2 cm gibi küçük desen kaymalarına izin verirken, her iki modülü de A ve B olarak farklı kodlarla ayırt eder. Bu yöntem sayesinde mekanlarda estetik ve görsel çeşitlilik elde edilirken, tasarımın bütünlüğü korunur.

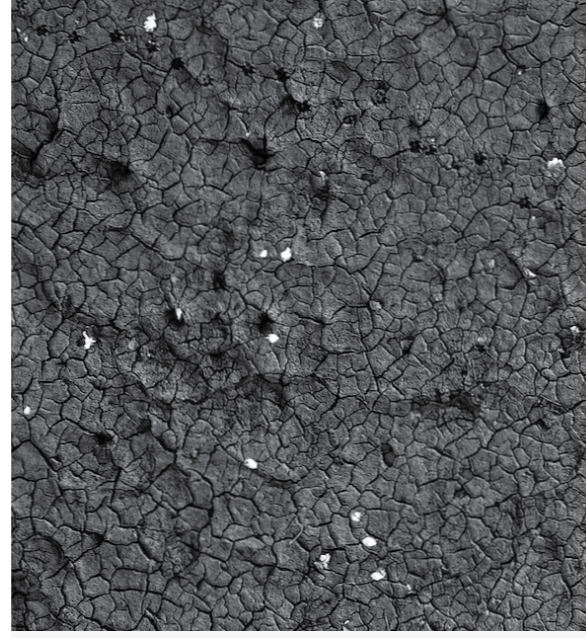

FORMTECH

The Technology Of Sensation

Dokunun Teknolojisi



Porcelain slabs mimicking the appearance of natural stone carry aesthetic elegance to living spaces. FORMTECH shapes porcelain slabs with inspiration from nature.

Bringing surfaces an embossed and ragged feel, FORMTECH technology adds depth to spaces. Special surfaces adapted to different patterns, textures and colors offer visual richness to living spaces. It creates a more attractive and unique atmosphere in every space.

Yüzeyle kabartmalı ve pütürlü bir dokunuş hissiyatı kazandıran FORMTECH teknolojisi, mekanlara derinlik ekler. Farklı desen ve renklere uyarlanan özel yüzeyler, yaşam alanlarına görsel zenginlik sunar. Her mekanda daha çekici ve özgün bir atmosfer yaratır.



Solid Colors / Düz Renkler



INNOVATION EXTRA WHITE
INNOVATION EXTRA BEYAZ

mm	Matte Mat	Soft Matte Soft Mat	Polished Parlak	Satin Saten
100x300 cm	3 5	•		
120x360 cm	3 5	•		
160x320 cm	6 12 20		•	•

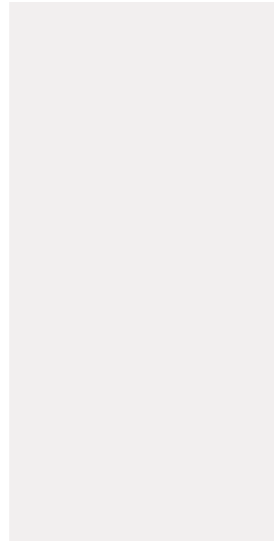

INNOVATION WHITE 2.0
INNOVATION BEYAZ 2.0

mm	Matte Mat	Soft Matte Soft Mat	Polished Parlak	Satin Saten
100x300 cm	3 5	•		
120x360 cm	3 5	•		
160x320 cm	6 12 20		•	

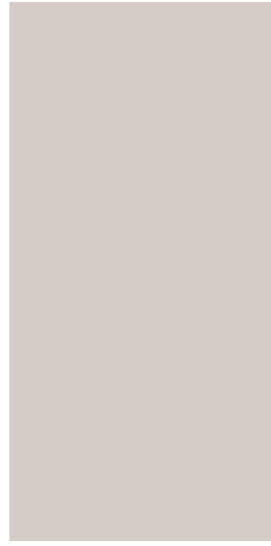

INNOVATION BEIGE
INNOVATION BEJ

mm	Matte Mat	Soft Matte Soft Mat	Polished Parlak	Satin Saten
100x300 cm	3 5	•		
120x360 cm	3 5	•		
160x320 cm	6 12 20			

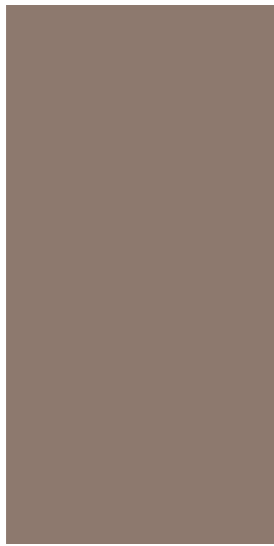

INNOVATION BEIGE-GREY
INNOVATION BEJ-GRİ

mm	Matte Mat	Soft Matte Soft Mat	Polished Parlak	Satin Saten
100x300 cm	3 5	•		
120x360 cm	3 5	•		
160x320 cm	6 12 20			

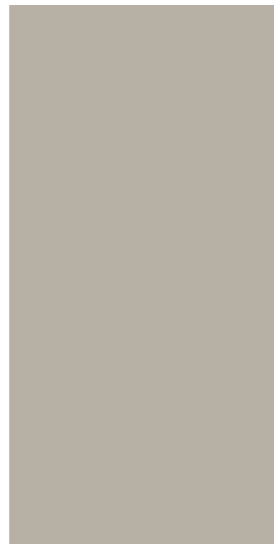

INNOVATION CEMENT GREY
INNOVATION CEMENT GRİ

mm	Matte Mat	Soft Matte Soft Mat	Polished Parlak	Satin Saten
100x300 cm	3 5	•		
120x360 cm	3 5	•		
160x320 cm	6 12 20			



INNOVATION PISTACHIO GREEN
INNOVATION FISTIK YEŞİLİ

mm	Matte Mat	Soft Matte Soft Mat	Polished Parlak	Satin Saten
100x300 cm	3 5	•		
120x360 cm	3 5	•		
160x320 cm	6 12 20			



Solid Colors / Düz Renkler



INNOVATION ORANGE
INNOVATION TURUNCU

mm	Matte Mat	Soft Matte Soft Mat	Polished Parlak	Satin Saten
100x300 cm	3 5	•		
120x360 cm	3 5			
160x320 cm	6 12 20			



INNOVATION CORAL
INNOVATION KIZIL

mm	Matte Mat	Soft Matte Soft Mat	Polished Parlak	Satin Saten
100x300 cm	3 5	•		
120x360 cm	3 5			
160x320 cm	6 12 20			



INNOVATION BLUE
INNOVATION MAVİ

mm	Matte Mat	Soft Matte Soft Mat	Polished Parlak	Satin Saten
100x300 cm	3 5	•		
120x360 cm	3 5			
160x320 cm	6 12 20			



INNOVATION MEGA BLACK
INNOVATION MEGA SİYAH

mm	Matte Mat	Soft Matte Soft Mat	Polished Parlak	Satin Saten
100x300 cm	3 5	•		
120x360 cm	3 5	•		
160x320 cm	6 12 20	•	•	



LEDER BROWN
LEDER KAHVE

mm	Matte Mat	Soft Matte Soft Mat	Polished Parlak	Satin Saten
100x300 cm	3 5	•		
120x360 cm	3 5			
160x320 cm	6 12 20			



INNOVATION BROWN
INNOVATION KAHVE

mm	Matte Mat	Soft Matte Soft Mat	Polished Parlak	Satin Saten
100x300 cm	3 5	•		
120x360 cm	3 5			
160x320 cm	6 12 20			



INNOVATION DARK GREY
INNOVATION KOYU GRİ

mm	Matte Mat	Soft Matte Soft Mat	Polished Parlak	Satin Saten
100x300 cm	3 5	•		
120x360 cm	3 5			
160x320 cm	6 12 20			

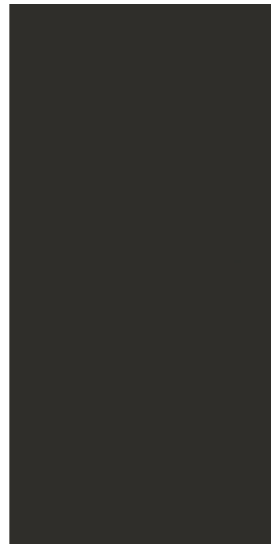

INNOVATION BLACK
INNOVATION SİYAH

mm	Matte Mat	Soft Matte Soft Mat	Polished Parlak	Satin Saten
100x300 cm	3 5	•		
120x360 cm	3 5	•		
160x320 cm	6 12 20	•		

Cement / Çimento



LUXURY CEMENT WHITE
LUXURY CEMENT BEYAZ

mm	Matte Mat	Soft Matte Soft Mat	Polished Parlak	Satin Saten
100x300 cm	3 5	•		
120x360 cm	3 5	•		
160x320 cm	6 12 20		•	



LUXURY CEMENT BEIGE
LUXURY CEMENT BEJ

mm	Matte Mat	Soft Matte Soft Mat	Polished Parlak	Satin Saten
100x300 cm	3 5	•		
120x360 cm	3 5	•		
160x320 cm	6 12 20		•	



LUXURY CEMENT GREY
LUXURY CEMENT GRİ

mm	Matte Mat	Soft Matte Soft Mat	Polished Parlak	Satin Saten
100x300 cm	3 5	•		
120x360 cm	3 5	•		
160x320 cm	6 12 20		•	



LUXURY CEMENT
LUXURY ÇİMENTO

mm	Matte Mat	Soft Matte Soft Mat	Polished Parlak	Satin Saten
100x300 cm	3 5	•		
120x360 cm	3 5	•		
160x320 cm	6 12 20		•	



LUXURY CEMENT MINK
LUXURY CEMENT VİZON

mm	Matte Mat	Soft Matte Soft Mat	Polished Parlak	Satin Saten
100x300 cm	3 5	•		
120x360 cm	3 5	•		
160x320 cm	6 12 20		•	



LUXURY CEMENT ANTHRACİTE
LUXURY CEMENT ANTRASİT

mm	Matte Mat	Soft Matte Soft Mat	Polished Parlak	Satin Saten
100x300 cm	3 5	•		
120x360 cm	3 5	•		
160x320 cm	6 12 20		•	



LUXURY CEMENT ANTHI

mm	Matte Mat	Soft Matte Soft Mat	Polished Parlak	Satin Saten
100x300 cm	3 5	•		
120x360 cm	3 5	•		
160x320 cm	6 12 20		•	



LUXURY CEMENT BROWN
LUXURY CEMENT KAHVE

mm	Matte Mat	Soft Matte Soft Mat	Polished Parlak	Satin Saten
100x300 cm	3 5	•		
120x360 cm	3 5	•		
160x320 cm	6 12 20		•	



ARCHE WHITE
ARCHE BEYAZ

mm	Matte Mat	Soft Matte Soft Mat	Polished Parlak	Satin Saten
100x300 cm	3 5	•		
120x360 cm	3 5	•		
160x320 cm	6 12 20		•	



ARCHE GREY
ARCHE GRİ

mm	Matte Mat	Soft Matte Soft Mat	Polished Parlak	Satin Saten
100x300 cm	3 5	•		
120x360 cm	3 5	•		
160x320 cm	6 12 20		•	



HIGHWAY BONE
HIGHWAY KEMİK

mm	Matte Mat	Soft Matte Soft Mat	Polished Parlak	Satin Saten
100x300 cm	3 5	•		
120x360 cm	3 5	•		
160x320 cm	6 12 20		•	

Cement / Çimento

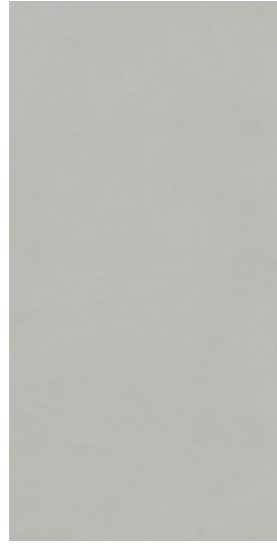

HUED OFF WHITE

mm	Matte Mat	Soft Matte Soft Mat	Polished Parlak	Satin Saten
100x300 cm	3 5	•		
120x360 cm	3 5	•		
160x320 cm	6 12 20			

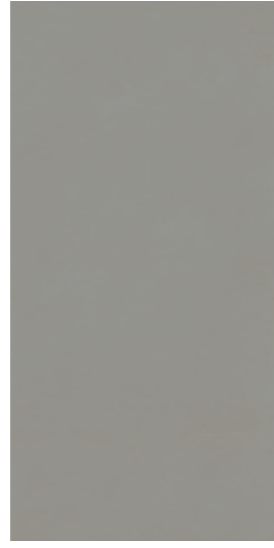

**HUED GREY
HUED GRİ**

mm	Matte Mat	Soft Matte Soft Mat	Polished Parlak	Satin Saten
100x300 cm	3 5	•		
120x360 cm	3 5	•		
160x320 cm	6 12 20			



**FACTORY BLACK
FACTORY SİYAH**

mm	Matte Mat	Soft Matte Soft Mat	Polished Parlak	Satin Saten
100x300 cm	3 5	•		
120x360 cm	3 5			
160x320 cm	6 12 20			



FACTORY GREIGE

mm	Matte Mat	Soft Matte Soft Mat	Polished Parlak	Satin Saten
100x300 cm	3 5	•		
120x360 cm	3 5			
160x320 cm	6 12 20			



**HUED DARK GREY
HUED KOYU GRİ**

mm	Matte Mat	Soft Matte Soft Mat	Polished Parlak	Satin Saten
100x300 cm	3 5	•		
120x360 cm	3 5	•		
160x320 cm	6 12 20			

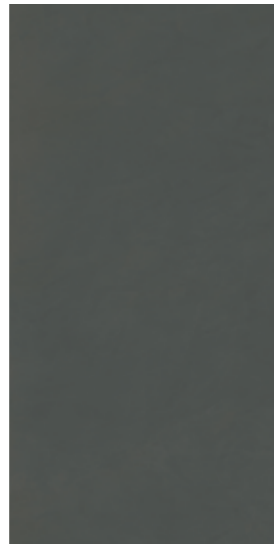

**HUED ANTHRACİTE
HUED ANTRASİT**

mm	Matte Mat	Soft Matte Soft Mat	Polished Parlak	Satin Saten
100x300 cm	3 5	•		
120x360 cm	3 5	•		
160x320 cm	6 12 20			



**FACTORY SILVER
FACTORY GÜMÜŞ**

mm	Matte Mat	Soft Matte Soft Mat	Polished Parlak	Satin Saten
100x300 cm	3 5	•		
120x360 cm	3 5			
160x320 cm	6 12 20			

Stone / Doğaltaş



**C-STONE WHITE
C-STONE BEYAZ**

mm	Matte Mat	Soft Matte Soft Mat	Polished Parlak	Satin Saten
100x300 cm	3 5	•		
120x360 cm	3 5	•		
160x320 cm	6 12 20			



**C-STONE BEIGE
C-STONE BEJ**

mm	Matte Mat	Soft Matte Soft Mat	Polished Parlak	Satin Saten
100x300 cm	3 5	•		
120x360 cm	3 5	•		
160x320 cm	6 12 20			



**C-STONE GREY
C-STONE GRİ**

mm	Matte Mat	Soft Matte Soft Mat	Polished Parlak	Satin Saten
100x300 cm	3 5	•		
120x360 cm	3 5	•		
160x320 cm	6 12 20			



TRAVERTINE SILVER

mm	Matte Mat	Soft Matte Soft Mat	Polished Parlak	Satin Saten
100x300 cm	3 5	•		
120x360 cm	3 5	•		
160x320 cm	6 12 20	•		



TRAVERTINE IVORY

mm	Matte Mat	Soft Matte Soft Mat	Polished Parlak	Satin Saten
100x300 cm	3 5	•		
120x360 cm	3 5	•		
160x320 cm	6 12 20	•		



**MONOLITH GREY
MONOLITH GRİ**

mm	Matte Mat	Soft Matte Soft Mat	Polished Parlak	Satin Saten
100x300 cm	3 5	•		
120x360 cm	3 5	•		
160x320 cm	6 12 20			



**C-STONE BROWN
C-STONE KAHVE**

mm	Matte Mat	Soft Matte Soft Mat	Polished Parlak	Satin Saten
100x300 cm	3 5	•		
120x360 cm	3 5	•		
160x320 cm	6 12 20			



**C-STONE ANTHRACİTE
C-STONE ANTRASİT**

mm	Matte Mat	Soft Matte Soft Mat	Polished Parlak	Satin Saten
100x300 cm	3 5	•		
120x360 cm	3 5	•		
160x320 cm	6 12 20			



QUARTZ ASH

mm	Matte Mat	Soft Matte Soft Mat	Polished Parlak	Satin Saten
100x300 cm	3 5	•		
120x360 cm	3 5			
160x320 cm	6 12 20			



RAPOLANO IVORY

mm	Matte Mat	Soft Matte Soft Mat	Polished Parlak	Satin Saten
100x300 cm	3 5	•		
120x360 cm	3 5	•		
160x320 cm	6 12 20	•		



RAPOLANO SILVER

mm	Matte Mat	Soft Matte Soft Mat	Polished Parlak	Satin Saten
100x300 cm	3 5	•		
120x360 cm	3 5	•		
160x320 cm	6 12 20	•		



**FLOW
TECH**



**PIAMONTE GREY
PIAMONTE GRİ**

mm	Matte Mat	Soft Matte Soft Mat	Polished Parlak	Satin Saten
100x300 cm	3 5	•		
120x360 cm	3 5	•		
160x320 cm	6 12 20			

Stone / Doğaltaş



PIETRA DI GRE GREY
PIETRA DI GRE GRİ

mm	Matte Mat	Soft Matte Soft Mat	Polished Parlak	Satin Saten
100x300 cm	3 5	•		
120x360 cm	3 5	•		
160x320 cm	6 12 20		• •	



PIETRA DI GRE BONE
PIETRA DI GRE KEMİK

mm	Matte Mat	Soft Matte Soft Mat	Polished Parlak	Satin Saten
100x300 cm	3 5	•		
120x360 cm	3 5	•		
160x320 cm	6 12 20		• •	



CITYSCAPE

mm	Matte Mat	Soft Matte Soft Mat	Polished Parlak	Satin Saten
100x300 cm	3 5			
120x360 cm	3 5			
160x320 cm	6 12 20	•		



UPTOWN LIGHT
UPTOWN AÇIK

mm	Matte Mat	Soft Matte Soft Mat	Polished Parlak	Satin Saten
100x300 cm	3 5	•		
120x360 cm	3 5	•		
160x320 cm	6 12 20			



UPTOWN DARK
UPTOWN KOYU

mm	Matte Mat	Soft Matte Soft Mat	Polished Parlak	Satin Saten
100x300 cm	3 5	•		
120x360 cm	3 5	•		
160x320 cm	6 12 20			



OCEAN WHITE
OCEAN BEYAZ

mm	Matte Mat	Soft Matte Soft Mat	Polished Parlak	Satin Saten
100x300 cm	3 5	•		
120x360 cm	3 5			
160x320 cm	6 12 20			



OCEAN BLACK
OCEAN SİYAH

mm	Matte Mat	Soft Matte Soft Mat	Polished Parlak	Satin Saten
100x300 cm	3 5	•		
120x360 cm	3 5			
160x320 cm	6 12 20			



PIETRA BASALTINA

mm	Matte Mat	Soft Matte Soft Mat	Polished Parlak	Satin Saten	Rock Surface Kaya Yüzeyi
100x300 cm	3 5	•			
120x360 cm	3 5				
160x320 cm	6 12 20		•		•

FORM
TECH



PIETRA CHATILLON

mm	Matte Mat	Soft Matte Soft Mat	Polished Parlak	Satin Saten
100x300 cm	3 5	•		
120x360 cm	3 5			
160x320 cm	6 12 20			

Stone / Doğaltaş



BRERA CREME

mm	Matte Mat	Soft Matte Soft Mat	Polished Parlak	Satin Saten
100x300 cm	3 5	•		
120x360 cm	3 5			
160x320 cm	6 12 20			



**PIETRA BLUE
PIETRA MAVİ**

mm	Matte Mat	Soft Matte Soft Mat	Polished Parlak	Satin Saten	Rock Surface Kaya Yüzeı
100x300 cm	3 5	•			
120x360 cm	3 5	•			
160x320 cm	6 12 20	•			•



**PIETRA GREY
PIETRA GRİ**

mm	Matte Mat	Soft Matte Soft Mat	Polished Parlak	Satin Saten	Rock Surface Kaya Yüzeı
100x300 cm	3 5	•			
120x360 cm	3 5				
160x320 cm	6 12 20	•			•



CALCARIO GREIGE

mm	Matte Mat	Soft Matte Soft Mat	Polished Parlak	Satin Saten	Rock Surface Kaya Yüzeı
100x300 cm	3 5	•			
120x360 cm	3 5				
160x320 cm	6 12 20	•			•



CALCARIO LINE GREIGE

mm	Matte Mat	Soft Matte Soft Mat	Polished Parlak	Satin Saten	Rock Surface Kaya Yüzeı
100x300 cm	3 5				
120x360 cm	3 5				
160x320 cm	6 12 20	•			



LECCESE LIGHT SAND

mm	Matte Mat	Soft Matte Soft Mat	Polished Parlak	Satin Saten
100x300 cm	3 5	•		
120x360 cm	3 5			
160x320 cm	6 12 20			



LECCESE DARK SAND

mm	Matte Mat	Soft Matte Soft Mat	Polished Parlak	Satin Saten
100x300 cm	3 5	•		
120x360 cm	3 5	•		
160x320 cm	6 12 20			



**LECCESE GREY
LECCESE GRİ**

mm	Matte Mat	Soft Matte Soft Mat	Polished Parlak	Satin Saten
100x300 cm	3 5	•		
120x360 cm	3 5			
160x320 cm	6 12 20			



CALCARIO LIGHT GREIGE

mm	Matte Mat	Soft Matte Soft Mat	Polished Parlak	Satin Saten	Rock Surface Kaya Yüzeı
100x300 cm	3 5	•			
120x360 cm	3 5				
160x320 cm	6 12 20	•			•



CALCARIO LINE LIGHT GREIGE

mm	Matte Mat	Soft Matte Soft Mat	Polished Parlak	Satin Saten	Rock Surface Kaya Yüzeı
100x300 cm	3 5				
120x360 cm	3 5				
160x320 cm	6 12 20	•			

Stone / Doğaltaş



LIMESTONE

	mm	Matte Mat	Soft Matte Soft Mat	Polished Parlak	Satin Saten
100x300 cm	3	•			
	5	•			
120x360 cm	3	•			
	5	•			
160x320 cm	6				
	12				
	20				

Metallic / Metalik



METALLIC ANTHRACİTE
METALİK ANTRASİT

	mm	Matte Mat	Soft Matte Soft Mat	Polished Parlak	Satin Saten
100x300 cm	3	•			
	5	•			
120x360 cm	3				
	5				
160x320 cm	6				
	12		•		
	20				



METALLIC CORAL
METALİK KIZIL

	mm	Matte Mat	Soft Matte Soft Mat	Polished Parlak	Satin Saten
100x300 cm	3	•			
	5	•			
120x360 cm	3				
	5				
160x320 cm	6				
	12				
	20				

Metallic / Metalik

Woodline / Ahşap



CORTEN

mm	Matte Mat	Soft Matte Soft Mat	Polished Parlak	Satin Saten
100x300 cm	3			
	5			
120x360 cm	3			
	5			
160x320 cm	6	•		
	12			
	20			



RUSTONE

mm	Matte Mat	Soft Matte Soft Mat	Polished Parlak	Satin Saten
100x300 cm	3			
	5			
120x360 cm	3			
	5			
160x320 cm	6	•		
	12	•		
	20			



**HOLLYWOOD BEIGE
HOLLYWOOD BEJ**

mm	Matte Mat	Soft Matte Soft Mat	Polished Parlak	Satin Saten
100x300 cm	3	•		
	5	•		
120x360 cm	3	•		
	5	•		
160x320 cm	6			
	12			
	20			



**HOLLYWOOD BROWN
HOLLYWOOD KAHVE**

mm	Matte Mat	Soft Matte Soft Mat	Polished Parlak	Satin Saten
100x300 cm	3			
	5			
120x360 cm	3	•		
	5	•		
160x320 cm	6			
	12	•		
	20			



FERRO

mm	Matte Mat	Soft Matte Soft Mat	Polished Parlak	Satin Saten
100x300 cm	3	•		
	5	•		
120x360 cm	3	•		
	5	•		
160x320 cm	6			
	12			
	20			



STEEL

mm	Matte Mat	Soft Matte Soft Mat	Polished Parlak	Satin Saten
100x300 cm	3	•		
	5	•		
120x360 cm	3	•		
	5	•		
160x320 cm	6			
	12			
	20			

* Gleaming Surface: Regional shiny / sparkle effect on matte surface.
*Parıltılı Yüzey: Mat yüzey üzerinde bölgesel ışık / parıltı efekti.

Woodline / Ahşap



**WOODLINE WALNUT
WOODLINE CEVİZ**

mm	Matte Mat	Soft Matte Soft Mat	Polished Parlak	Satin Saten
100x300 cm	3 5	•		
120x360 cm	3 5			
160x320 cm	6 12 20			



**WOODLINE CHERRY
WOODLINE KIRAZ**

mm	Matte Mat	Soft Matte Soft Mat	Polished Parlak	Satin Saten
100x300 cm	3 5	•		
120x360 cm	3 5			
160x320 cm	6 12 20			



**WOODLINE OAK
WOODLINE MEŞE**

mm	Matte Mat	Soft Matte Soft Mat	Polished Parlak	Satin Saten
100x300 cm	3 5	•		
120x360 cm	3 5			
160x320 cm	6 12 20			



PLANK BG 114

mm	Matte Mat	Soft Matte Soft Mat	Polished Parlak	Satin Saten
100x300 cm	3 5	•		
120x360 cm	3 5			
160x320 cm	6 12 20			



**SHELL WOOD DARK
SHELL WOOD KOYU**

mm	Matte Mat	Soft Matte Soft Mat	Polished Parlak	Satin Saten
100x300 cm	3 5	•		
120x360 cm	3 5	•		
160x320 cm	6 12 20			



PLANK BG 104

mm	Matte Mat	Soft Matte Soft Mat	Polished Parlak	Satin Saten
100x300 cm	3 5	•		
120x360 cm	3 5			
160x320 cm	6 12 20			



PLANK BG 110

mm	Matte Mat	Soft Matte Soft Mat	Polished Parlak	Satin Saten
100x300 cm	3 5	•		
120x360 cm	3 5			
160x320 cm	6 12 20			



PLANK BG 111

mm	Matte Mat	Soft Matte Soft Mat	Polished Parlak	Satin Saten
100x300 cm	3 5	•		
120x360 cm	3 5			
160x320 cm	6 12 20			

Marble Black and White / Mermer Siyah ve Beyaz



STATUARIO

mm	Matte Mat	Soft Matte Soft Mat	Polished Parlak	Satin Saten
100x300 cm	3			
	5			
120x360 cm	3			
	5			
160x320 cm	6		•	
	12		•	
	20			



CALACATTA CALDIA

mm	Matte Mat	Soft Matte Soft Mat	Polished Parlak	Satin Saten
100x300 cm	3	•		
	5	•		
120x360 cm	3	•		
	5	•		
160x320 cm	6		•	
	12		•	
	20		•	



CALACATTA GOLD*

mm	Matte Mat	Soft Matte Soft Mat	Polished Parlak	Satin Saten
100x300 cm	3	•		
	5	•		
120x360 cm	3	•		
	5	•		
160x320 cm	6		•	
	12		•	
	20		•	



CALACATTA 2.0

mm	Matte Mat	Soft Matte Soft Mat	Polished Parlak	Satin Saten
100x300 cm	3	•		
	5	•		
120x360 cm	3	•		
	5	•		
160x320 cm	6			
	12			
	20			



BRONZE LINE

mm	Matte Mat	Soft Matte Soft Mat	Polished Parlak	Satin Saten
100x300 cm	3			
	5			
120x360 cm	3			
	5			
160x320 cm	6		•	
	12		•	
	20			



PALISSANDRO*

mm	Matte Mat	Soft Matte Soft Mat	Polished Parlak	Satin Saten
100x300 cm	3	•		
	5	•		
120x360 cm	3	•		
	5	•		
160x320 cm	6			
	12			
	20			



CALACATTA UNIQUE OPENBOOK

mm	Matte Mat	Soft Matte Soft Mat	Polished Parlak	Satin Saten
100x300 cm	3	•		
	5	•		
120x360 cm	3	•		
	5	•		
160x320 cm	6		•	
	12		•	
	20			

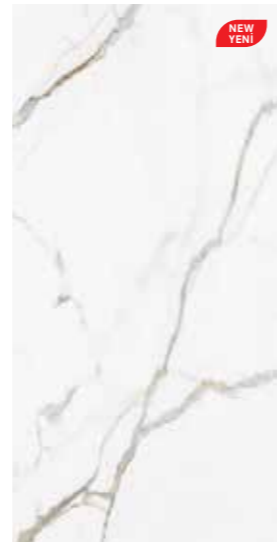

CALACATTA UNIQUE

mm	Matte Mat	Soft Matte Soft Mat	Polished Parlak	Satin Saten
100x300 cm	3	•		
	5	•		
120x360 cm	3	•		
	5	•		
160x320 cm	6		•	
	12		•	
	20			

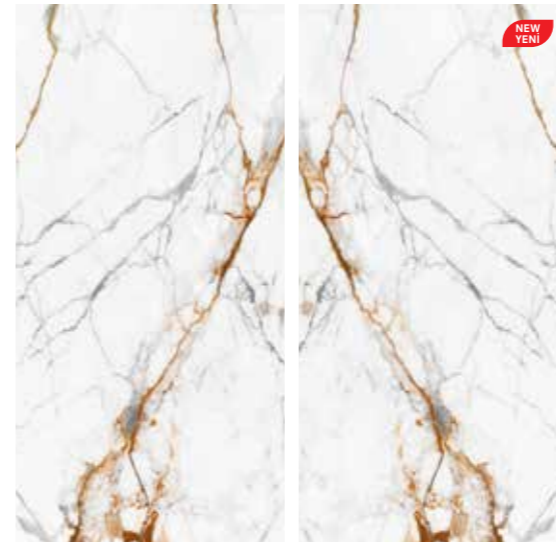

GOLDEN HOUR OPENBOOK

mm	Matte Mat	Soft Matte Soft Mat	Polished Parlak	Satin Saten
100x300 cm	3			
	5			
120x360 cm	3			
	5			
160x320 cm	6		•	
	12		•	
	20			



GOLDEN HOUR

mm	Matte Mat	Soft Matte Soft Mat	Polished Parlak	Satin Saten
100x300 cm	3			
	5			
120x360 cm	3			
	5			
160x320 cm	6		•	
	12		•	
	20			

Marble Black and White / Mermer Siyah ve Beyaz

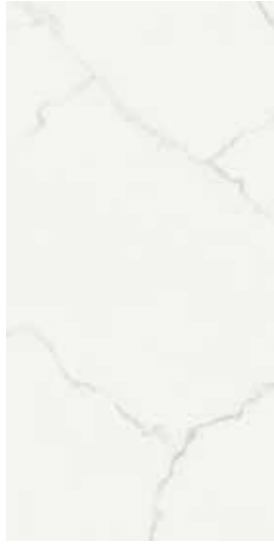

CALACATTA ICE

mm	Matte Mat	Soft Matte Soft Mat	Polished Parlak	Satin Saten
100x300 cm	3 5	•		
120x360 cm	3 5	•		
160x320 cm	6 12 20			



WINTERLAND*

mm	Matte Mat	Soft Matte Soft Mat	Polished Parlak	Satin Saten
100x300 cm	3 5	•		
120x360 cm	3 5	•		
160x320 cm	6 12 20			



COLORADO ORO OPENBOOK

mm	Matte Mat	Soft Matte Soft Mat	Polished Parlak	Satin Saten
100x300 cm	3 5	•		
120x360 cm	3 5			
160x320 cm	6 12 20			



COLORADO ORO

mm	Matte Mat	Soft Matte Soft Mat	Polished Parlak	Satin Saten
100x300 cm	3 5	•		
120x360 cm	3 5			
160x320 cm	6 12 20			



CALACATTA MACCHIA

mm	Matte Mat	Soft Matte Soft Mat	Polished Parlak	Satin Saten
100x300 cm	3 5	•		
120x360 cm	3 5	•		
160x320 cm	6 12 20	•	•	



CALACATTA VIOLA

mm	Matte Mat	Soft Matte Soft Mat	Polished Parlak	Satin Saten
100x300 cm	3 5			
120x360 cm	3 5			
160x320 cm	6 12 20		•	

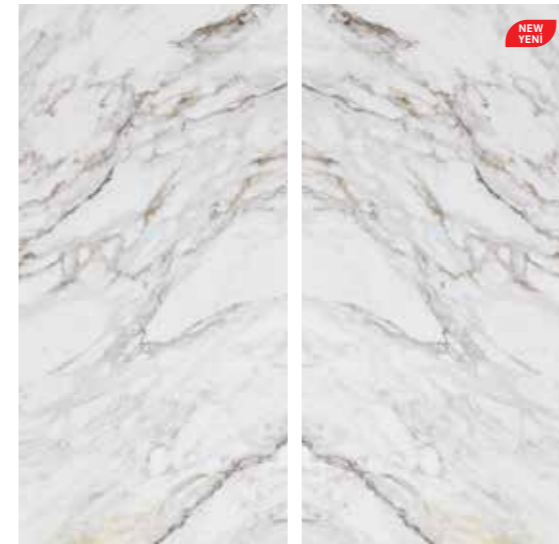

FLORENCE OPENBOOK

mm	Matte Mat	Soft Matte Soft Mat	Polished Parlak	Satin Saten
100x300 cm	3 5			
120x360 cm	3 5			
160x320 cm	6 12 20	•	•	



FLORENCE

mm	Matte Mat	Soft Matte Soft Mat	Polished Parlak	Satin Saten
100x300 cm	3 5			
120x360 cm	3 5			
160x320 cm	6 12 20	•	•	



* Gleaming Surface: Regional shiny / sparkle effect on matte surface.
* Parıltılı Yüzey: Mat yüzey üzerinde bölgesel ışıltı / parıltı efekti.

* Gleaming Surface: Regional shiny / sparkle effect on matte surface.
* Parıltılı Yüzey: Mat yüzey üzerinde bölgesel ışıltı / parıltı efekti.



Marble Black and White / Mermer Siyah ve Beyaz

Marble Exclusive / Mermer Exclusive

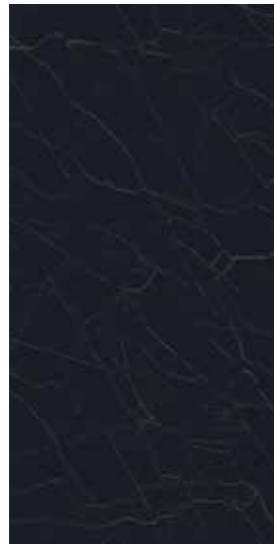

PORT LAURENT

mm	Matte Mat	Soft Matte Soft Mat	Polished Parlak	Satin Saten
100x300 cm	3 5	•		
120x360 cm	3 5	•		
160x320 cm	6 12 20	•	•	

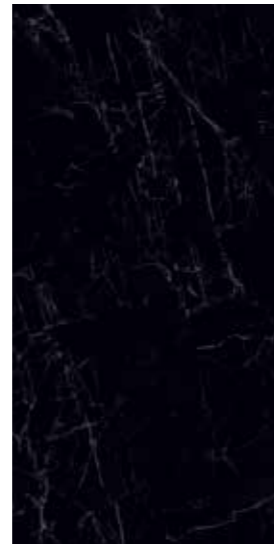

MARBLE DARK

mm	Matte Mat	Soft Matte Soft Mat	Polished Parlak	Satin Saten
100x300 cm	3 5	•		
120x360 cm	3 5	•		
160x320 cm	6 12 20			



PATAGONIA OPENBOOK

mm	Matte Mat	Soft Matte Soft Mat	Polished Parlak	Satin Saten
100x300 cm	3 5			
120x360 cm	3 5			
160x320 cm	6 12 20	•	•	



PATAGONIA

mm	Matte Mat	Soft Matte Soft Mat	Polished Parlak	Satin Saten
100x300 cm	3 5			
120x360 cm	3 5			
160x320 cm	6 12 20	•	•	

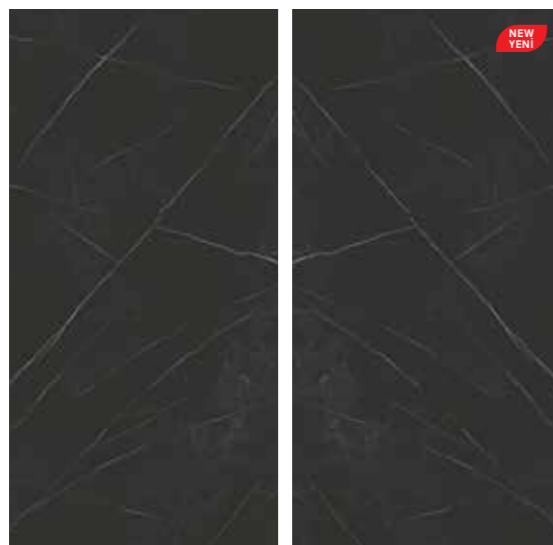

PIETRA NERO OPENBOOK

mm	Matte Mat	Soft Matte Soft Mat	Polished Parlak	Satin Saten
100x300 cm	3 5	•		
120x360 cm	3 5	•		
160x320 cm	6 12 20	•	•	

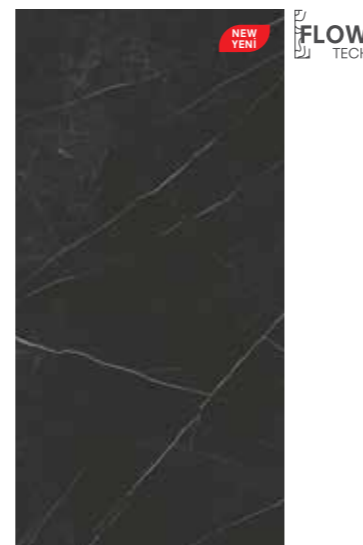

PIETRA NERO

mm	Matte Mat	Soft Matte Soft Mat	Polished Parlak	Satin Saten
100x300 cm	3 5	•		
120x360 cm	3 5	•		
160x320 cm	6 12 20	•	•	



QUARZITE J'ADORE OPENBOOK

mm	Matte Mat	Soft Matte Soft Mat	Polished Parlak	Satin Saten
100x300 cm	3 5			
120x360 cm	3 5			
160x320 cm	6 12 20		•	•



QUARZITE J'ADORE

mm	Matte Mat	Soft Matte Soft Mat	Polished Parlak	Satin Saten
100x300 cm	3 5			
120x360 cm	3 5			
160x320 cm	6 12 20		•	•

Marble Exclusive / Mermer Exclusive



NEW YENI FLOW TECH

SARRANCOLIN

mm	Matte Mat	Soft Matte Soft Mat	Polished Parlak	Satin Saten
100x300 cm	3			
	5			
120x360 cm	3			
	5			
160x320 cm	6			
	12	•	•	
	20			



OLIMPO*

mm	Matte Mat	Soft Matte Soft Mat	Polished Parlak	Satin Saten
100x300 cm	3	•		
	5			
120x360 cm	3	•		
	5			
160x320 cm	6			
	12	•	•	
	20			



FLOW TECH
DECO TECH

MARMO METALLO*

mm	Matte Mat	Soft Matte Soft Mat	Polished Parlak	Satin Saten
100x300 cm	3	•		
	5			
120x360 cm	3	•		
	5			
160x320 cm	6			
	12	•		
	20			

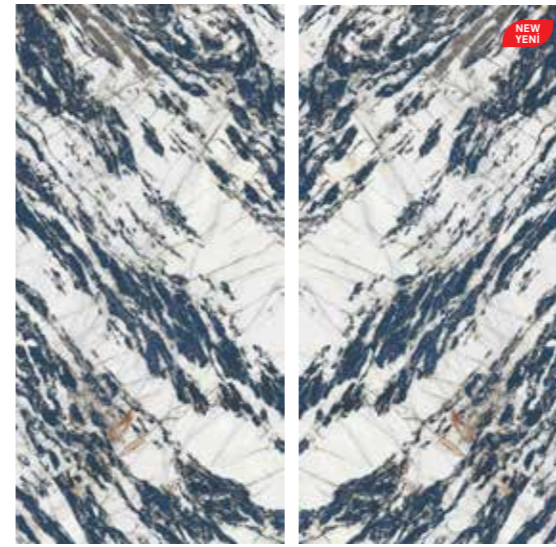

NEW YENI FLOW TECH
OPEN BOOK

TIFFANY BLUE OPENBOOK

mm	Matte Mat	Soft Matte Soft Mat	Polished Parlak	Satin Saten
100x300 cm	3			
	5			
120x360 cm	3			
	5			
160x320 cm	6		•	
	12			
	20			



NEW YENI FLOW TECH

TIFFANY BLUE

mm	Matte Mat	Soft Matte Soft Mat	Polished Parlak	Satin Saten
100x300 cm	3			
	5			
120x360 cm	3			
	5			
160x320 cm	6		•	
	12			
	20			



NEW YENI FLOW TECH

ALASKA WHITE

mm	Matte Mat	Soft Matte Soft Mat	Polished Parlak	Satin Saten
100x300 cm	3			
	5			
120x360 cm	3			
	5			
160x320 cm	6			
	12		•	
	20			



NEW YENI FLOW TECH

MARINA

mm	Matte Mat	Soft Matte Soft Mat	Polished Parlak	Satin Saten
100x300 cm	3			
	5			
120x360 cm	3			
	5			
160x320 cm	6			
	12		•	
	20			



VERSAILLES

mm	Matte Mat	Soft Matte Soft Mat	Polished Parlak	Satin Saten
100x300 cm	3			
	5			
120x360 cm	3			
	5			
160x320 cm	6			
	12	•	•	
	20			



SAHARA BROWN
SAHARA KAHVE

mm	Matte Mat	Soft Matte Soft Mat	Polished Parlak	Satin Saten
100x300 cm	3	•		
	5			
120x360 cm	3			
	5			
160x320 cm	6			
	12	•		
	20			



ALAMEDA

mm	Matte Mat	Soft Matte Soft Mat	Polished Parlak	Satin Saten
100x300 cm	3	•		
	5			
120x360 cm	3	•		
	5			
160x320 cm	6			
	12			
	20			



SEA NATURE

mm	Matte Mat	Soft Matte Soft Mat	Polished Parlak	Satin Saten
100x300 cm	3	•		
	5			
120x360 cm	3			
	5			
160x320 cm	6			
	12			
	20			

Marble Exclusive / Mermer Exclusive

Marble Timeless / Mermer Klasik



ASTEROID

mm	Matte Mat	Soft Matte Soft Mat	Polished Parlak	Satin Saten
100x300 cm	3 5	•		
120x360 cm	3 5	•		
160x320 cm	6 12 20			



MOCHA PERLA

mm	Matte Mat	Soft Matte Soft Mat	Polished Parlak	Satin Saten
100x300 cm	3 5	•		
120x360 cm	3 5	•		
160x320 cm	6 12 20			



NAMIBIA

mm	Matte Mat	Soft Matte Soft Mat	Polished Parlak	Satin Saten
100x300 cm	3 5			
120x360 cm	3 5			
160x320 cm	6 12 20		•	



TRANSLUCENT

mm	Matte Mat	Soft Matte Soft Mat	Polished Parlak	Satin Saten
100x300 cm	3 5	•		
120x360 cm	3 5			
160x320 cm	6 12 20			



FIORI DI BOSCO

mm	Matte Mat	Soft Matte Soft Mat	Polished Parlak	Satin Saten
100x300 cm	3 5			
120x360 cm	3 5			
160x320 cm	6 12 20	•	•	



CRYSTALLUS

mm	Matte Mat	Soft Matte Soft Mat	Polished Parlak	Satin Saten
100x300 cm	3 5			
120x360 cm	3 5			
160x320 cm	6 12 20		•	



DENISE

mm	Matte Mat	Soft Matte Soft Mat	Polished Parlak	Satin Saten
100x300 cm	3 5			
120x360 cm	3 5			
160x320 cm	6 12 20	•	•	



PULPIS

mm	Matte Mat	Soft Matte Soft Mat	Polished Parlak	Satin Saten
100x300 cm	3 5	•		
120x360 cm	3 5	•		
160x320 cm	6 12 20			



TRAVERTINO

mm	Matte Mat	Soft Matte Soft Mat	Polished Parlak	Satin Saten
100x300 cm	3 5			
120x360 cm	3 5	•		
160x320 cm	6 12 20			



Technical Information & Characteristics

Teknik Bilgiler & Özellikler

Technical Specifications for Kalesinterflex® Hidden Clips Fitted Facade System

Kalesinterflex® Gizli Klipsli Sistem Cephe Kaplama Teknik Şartnamesi

KALESİTERFLEX®

Facade material composed with porcelain ceramic front face in dimensions 1000x3000mm and 1200cmx3600mm and in lower dimensions, 3mm- and 5mm-thick with back face laminated with fiber mesh, double-component polyurethane and epoxy resin (for concave and convex applications only).

BEARERS

— A6063-T6- quality bearer main aluminum anchorage connected to concrete:
L (70-150)x50x4mm h=150 and aluminum partition anchorage: L (70-150)x50x4mm h=80
— A6063-T6-quality and 2mm-wall-thick aluminum T profiles (Axis ranges and dimensions are determined according to building height and wind load)
— A6063-T6-quality bearer clips with 30x56mm cross section
— A6063-T6-quality horizontal aluminum hanger profiles (Axis ranges, quantity and cross sections of horizontal profiles are determined according to building height and wind load.)

FITTINGS

Wall – Anchorage connection:
M10x100 dowel, bolt, nut, washer
Anchorage - vertical bearer T profile connection = 2 pieces of 4,8x16mm cross recessed pan head screws
Vertical bearer clips connection = 2 pieces of 4,8x16mm cross recessed pan head screws
— Types and quantity of fittings are determined according to building height and wind load.

KALESİTERFLEX®

Görünen yüzeyi 1000x3000mm; 1200x3600mm ebadında ve alt ebatlarında; 3mm ve 5mm kalınlığında olan, arka yüzeyi cam elyaf file, çift komponentli poliüretan veya epoxy reçine (sadece içbükey ve dış bükey cephe uygulamalarında) ile lamine edilmiş porselen seramik cephe malzemesidir.

TAŞIYICI ELEMANLAR

— A6063-T6 kalitesinde betonarmeye bağlanan taşıyıcı ana alüminyum ankraj:
L (70-150)x50x4mm h=150 ve ara alüminyum ankraj: L (70-150)x50x4mm h=80
— A6063-T6 kalitesinde 2mm et kalınlığında alüminyum T profiller (Bina yüksekliği ve rüzgar yükü değerlerine bağlı olarak aks aralıkları ve ebatları belirlenir)
— A6063-T6 kalitesinde 30x56mm kesitli taşıyıcı klips
— A6063-T6 kalitesinde alüminyum yatay askı profilleri (Bina yüksekliği ve rüzgar yükü değerlerine bağlı olarak yatay profillerin aks aralıkları, adetleri ve kesitleri belirlenir.)

BAĞLANTI ELEMANLARI

Duvar - Ankraj bağlantısı:
M10x100 dübel, civata - somun - pul
Ankraj - düşey taşıyıcı T profil bağlantısı = 2 adet YSB 4,8x16mm vida
Düşey - taşıyıcı klips bağlantısı = 2 adet YSB 4,8x16mm vida
— (Bina yüksekliği ve rüzgar yükü değerlerine bağlı olarak bağlantı elemanlarının tip ve adetleri belirlenir.)

ASSEMBLY

Based on the measured drawings to be prepared from the site, the Kalesinterflex® panel layout drawings are prepared as per the standard details (as provided as an appendix to the specifications) in 3mm and 5mm thickness (fiberglass reinforced in the back) and dimensions of 1000x3000mm and 1200x3600mm. Aluminum horizontal mounting profiles are glued using polyurethane-based adhesives on the back side of the Kalesinterflex® dimensioned based on the project upon determining the axis ranges, quantity and cross sections according to building height and wind load values. Aluminum anchorages are fastened on the façade plane in such a way that the maximum distance from axis to axis is 100 cm based on the project. Vertical bearer aluminum T profiles are fixed on the façade plane at a distance of approximately 8 to 15 cm to the anchorages upon determining the axis ranges and dimensions according to building height and wind load. Porcelain ceramic panels are fixed on T profiles with wick aluminum clips. (Vertical joints must be 3 to 6mm.)

MONTAJ

Şantiyede alınacak röleveye göre, 1000x3000mm ve 1200x3600mm ebadında ve alt ebatlarında; 3mm ve 5mm kalınlığında (arkası cam elyaf takviyeli) Kalesinterflex® panel yerleşim projesi, standart detaylar (şartname ekinde verilmiştir) doğrultusunda çizilir. Bina yüksekliği ve rüzgar yükü değerlerine bağlı olarak aks aralıkları, adetleri ve kesitleri belirlenen alüminyum yatay askı profilleri; projeye uygun olarak ebatlanmış Kalesinterflex® arka kısımlarına poliüretan esaslı yapıştırıcı ile sabitlenir. Hazırlanan projeye uygun olarak, alüminyum ankrajlar cephe düzlemine, aks aralıkları maksimum 100 cm olacak şekilde sabitlenir. Bina yüksekliği ve rüzgar yükü değerlerine bağlı olarak aks aralıkları ve ebatları belirlenen düşey taşıyıcı alüminyum T profiller cephe düzleminin yaklaşık 8 – 15 cm önünde ankrajlar üzerine sabitlenir. Hazırlanan porselen seramik paneller fitilli alüminyum klipsler ile T profiller üzerine sabitlenir. (Düşey derzler 3-6mm olmalıdır.)



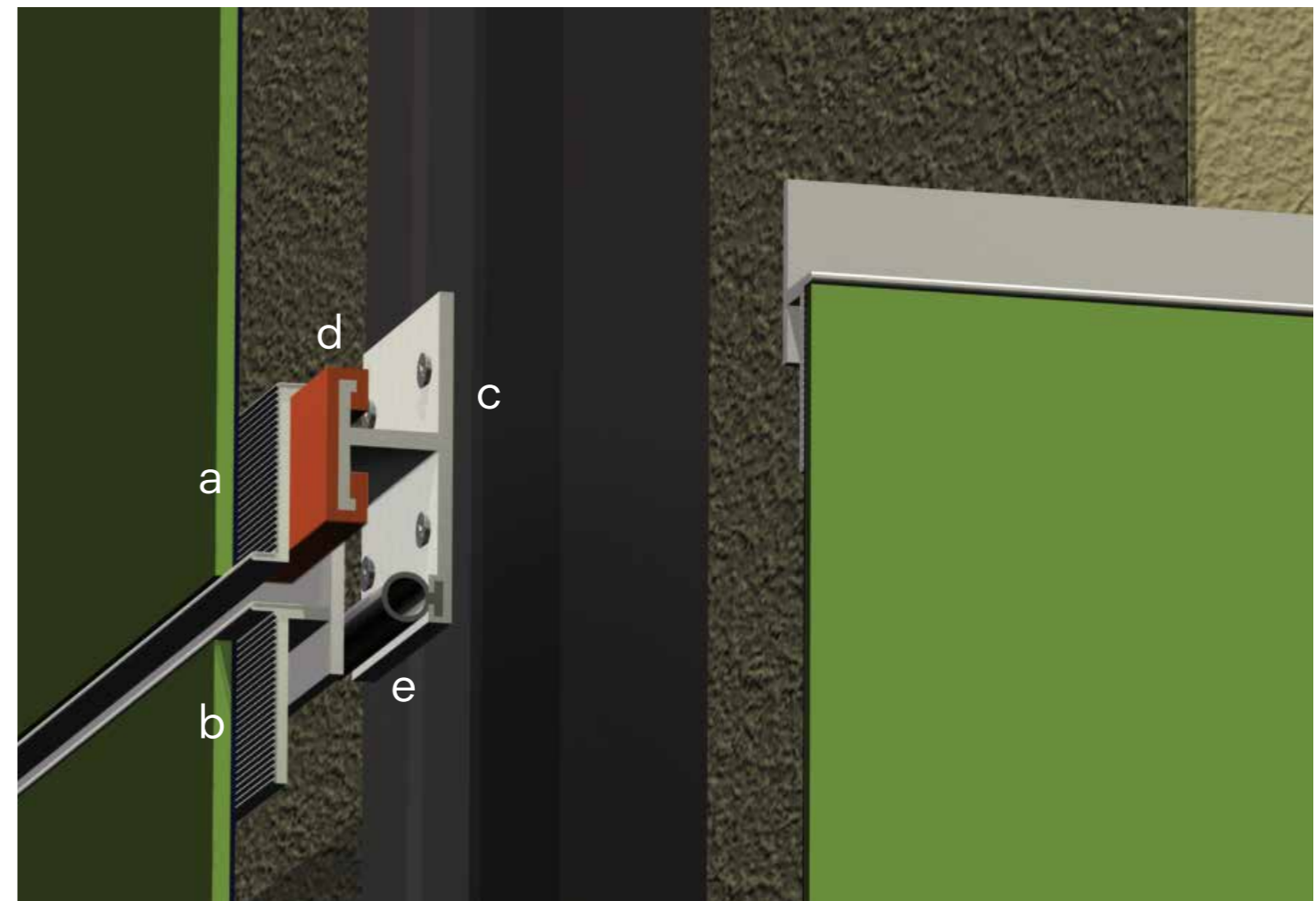
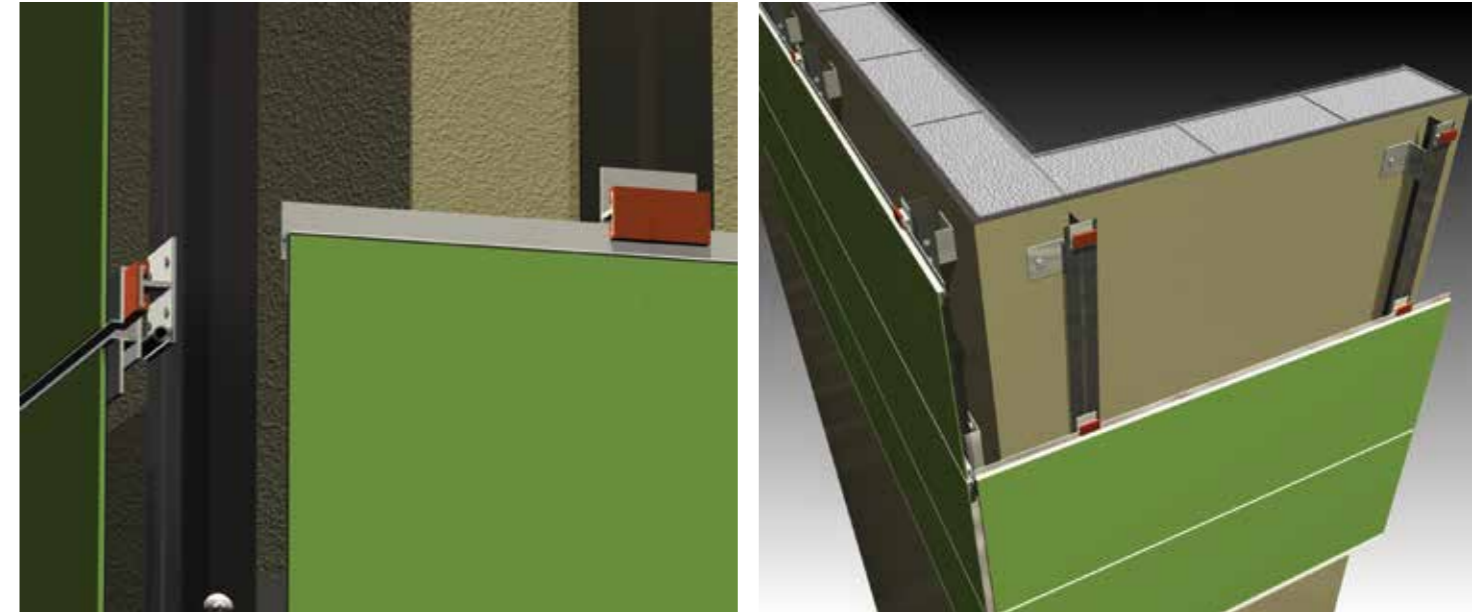
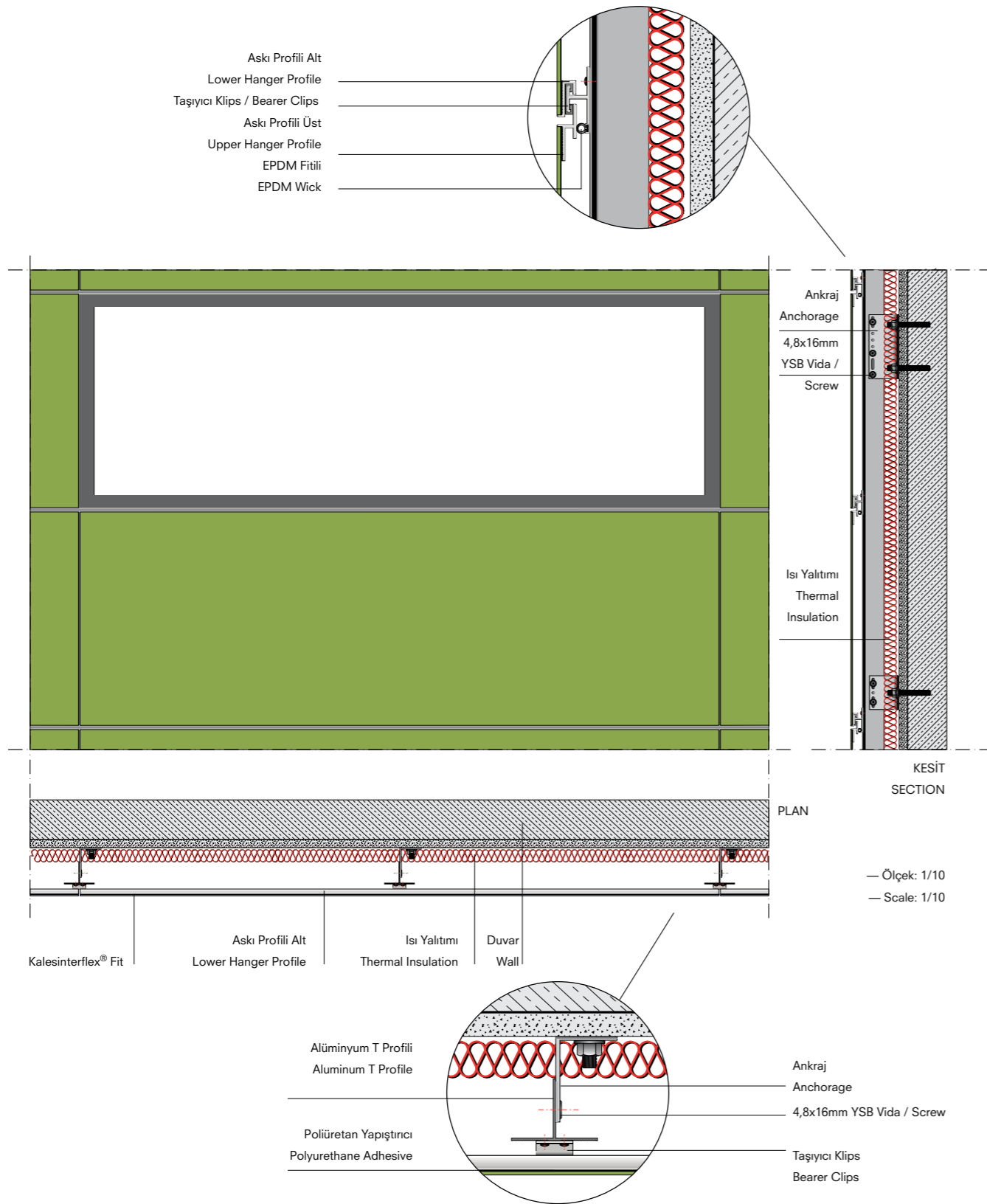

a - Lower Hanger Profile / Askı Profili Alt
b - Upper Hanger Profile / Askı Profili Üst
c - Bearer Clips / Taşıyıcı Klips

d - Wick / Fıtlı
e - Wick / Fıtlı

Internal Corner System Detail

İç Köşe - Dış Köşe Sistem Detayı

DIŞ KÖŞE

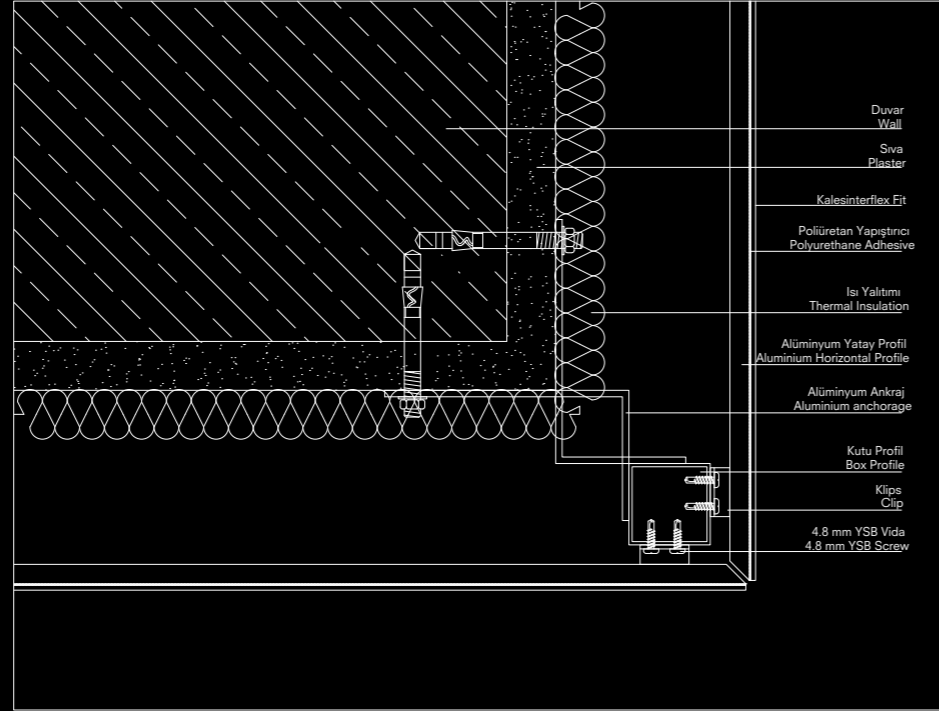

İÇ KÖŞE

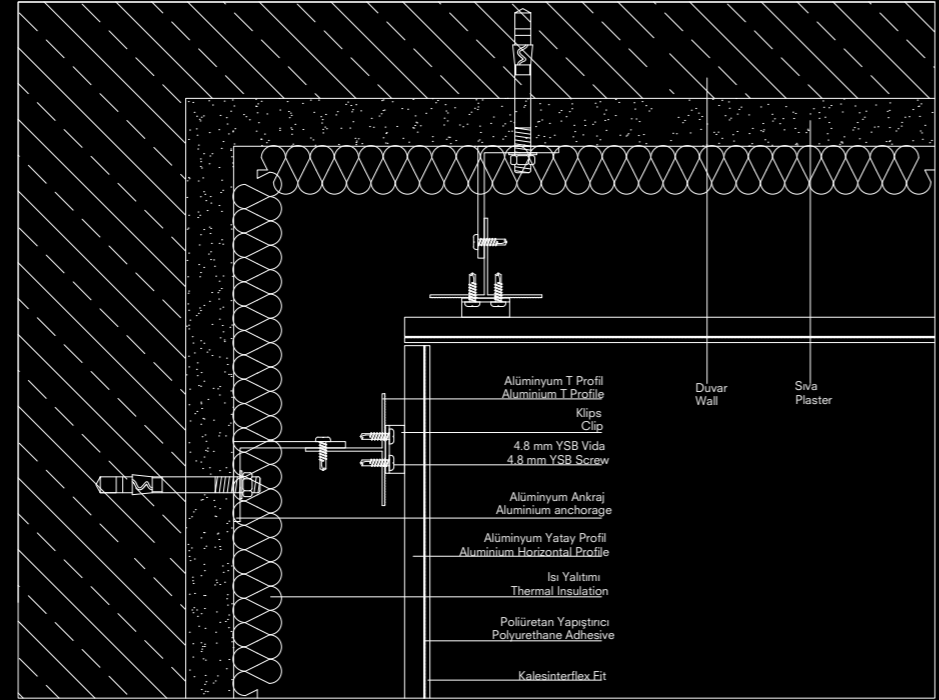

* The given values are approximate. All measurements of bearing construction will be determined by the facade or static project firm with regards to the facade static calculations.

* Verilen değerler yaklaşık değerlerdir. Her projede kullanılacak ölçüler cephe veya statik proje firması tarafından yapılacak cephe statik hesapları ile belirlenecektir.

System Details

Sistem Detayları

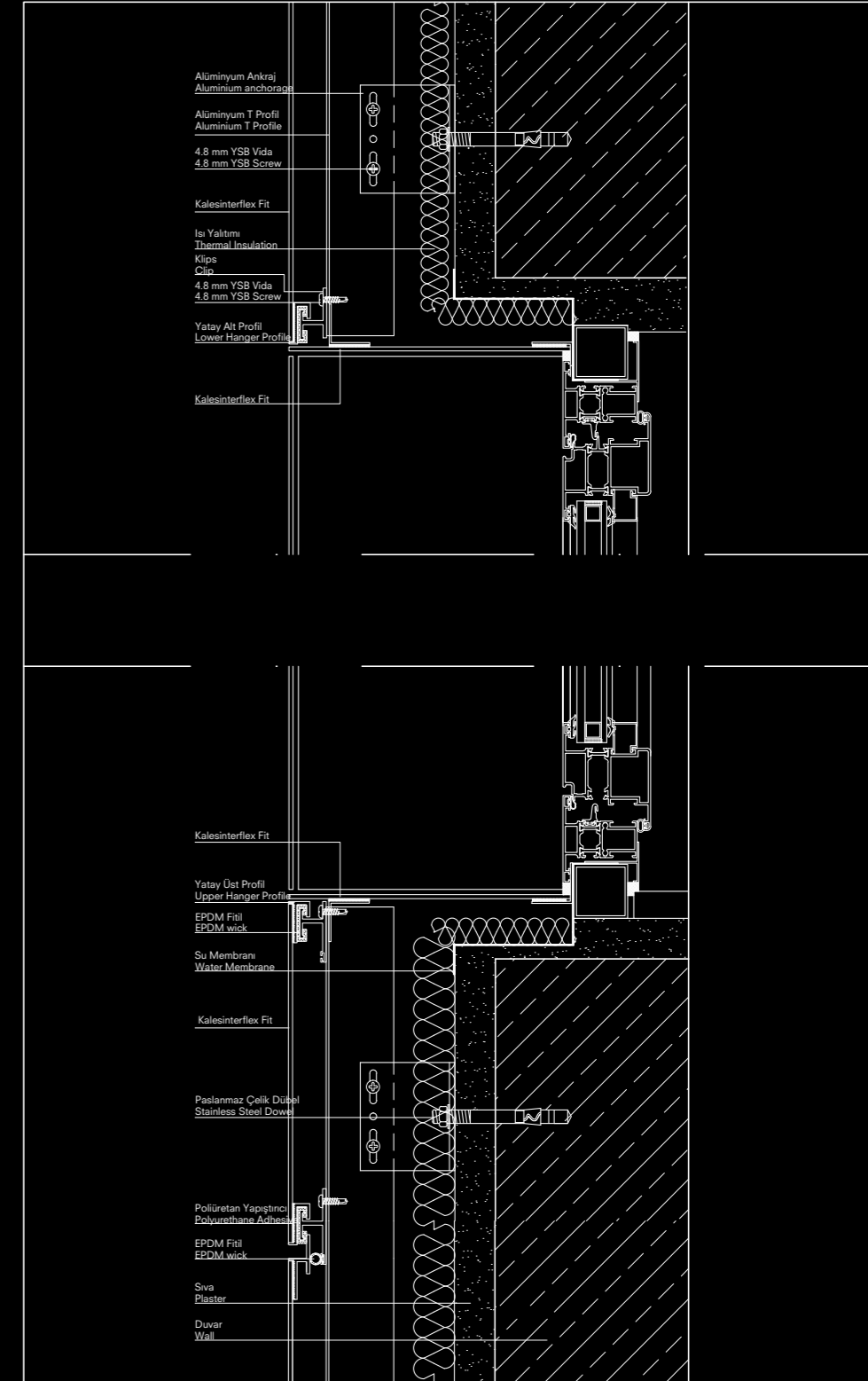

* The given values are approximate. All measurements of bearing construction will be determined by the facade or static project firm with regards to the facade static calculations.

* Verilen değerler yaklaşık değerlerdir. Her projede kullanılacak ölçüler cephe veya statik proje firması tarafından yapılacak cephe statik hesapları ile belirlenecektir.

Size Table / Kalesinterflex

TIPOLOJİ TYPOLOGY	SERİ SERIES	ÜRÜN PRODUCT	100x300		120x360		160x320/162x323			162x323			162x323			OPENBOOK
			3MM	5MM	3MM	5MM	6MM			12MM			20MM			
			MAT / MATTE		MAT / MATTE		SOFT MAT / SOFT MATTE	PARLAK / POLISHED	SATEN / SATIN	SOFT MAT / SOFT MATTE	PARLAK / POLISHED	SATEN	SOFT MAT / SOFT MATTE	PARLAK / POLISHED	KAYA YÜZEY / ROCK SURFACE	
MARBLE B&W / MERMER B&W	MARBLES	CALACATTA 2.0	X	X	X	X										
MARBLE B&W / MERMER B&W	CALCATTÀ UNIQUE	CALCATTÀ UNIQUE NEW / YENİ	X	X	X	X	X	X		X	X	X	X			X
MARBLE B&W / MERMER B&W	CALCATTÀ CALDIA	CALCATTÀ CALDIA NEW / YENİ	X	X	X	X	X	X		X	X	X				
MARBLE B&W / MERMER B&W	CALCATTÀ GOLD	CALCATTÀ GOLD	X		X		X	X		X	X	X				
MARBLE B&W / MERMER B&W	MARBLES	CALCATTÀ ICE	X		X											
MARBLE B&W / MERMER B&W	FLORENCE	FLORENCE NEW / YENİ					X	X		X	X					X
MARBLE B&W / MERMER B&W	GOLDEN HOUR	GOLDEN HOUR NEW / YENİ					X	X		X	X					X
MARBLE B&W / MERMER B&W	BRONZE LINE	BRONZE LINE NEW / YENİ					X	X		X	X					
MARBLE B&W / MERMER B&W	CALCATTÀ VIOLA	CALCATTÀ VIOLA NEW / YENİ									X					
MARBLE B&W / MERMER B&W	CALCATTÀ MACCHIA	CALCATTÀ MACCHIA		X		X	X	X		X	X					
MARBLE B&W / MERMER B&W	MARBLES	COLORODO ORO	X													X
MARBLE B&W / MERMER B&W	MARBLES	MARBLE DARK	X	X	X	X										
MARBLE B&W / MERMER B&W	PIETRA NERO	PIETRA NERO NEW / YENİ	X	X	X	X	X	X		X	X		X			X
MARBLE B&W / MERMER B&W	PALISSANDRO	PALISSANDRO	X	X	X	X	X			X						
MARBLE B&W / MERMER B&W	PORT LAURENT	PORT LAURENT	X	X	X	X	X	X		X	X					
MARBLE B&W / MERMER B&W	MARBLES	WINTERLAND	X	X	X	X										
MARBLE B&W / MERMER B&W	MARBLES	MARBLE STATUARIO								X	X					
MARBLE EXCLUSIVE / MERMER EXCLUSIVE	SAHARA BROWN / SAHARA KAHVE	SAHARA BROWN / SAHARA KAHVE	X				X			X						
MARBLE EXCLUSIVE / MERMER EXCLUSIVE	MARBLES	ALAMEDA	X		X											
MARBLE EXCLUSIVE / MERMER EXCLUSIVE	MARBLES	ASTEROID	X	X	X	X										
MARBLE EXCLUSIVE / MERMER EXCLUSIVE	MARMO METALLO	MARMO METALLO	X	X	X	X	X			X						
MARBLE EXCLUSIVE / MERMER EXCLUSIVE	MARBLES	MOCHA PERLA	X	X	X	X										
MARBLE EXCLUSIVE / MERMER EXCLUSIVE	MARBLES	OLIMPO	X	X	X	X	X	X		X						
MARBLE EXCLUSIVE / MERMER EXCLUSIVE	SARRANCOLIN	SARRANCOLIN NEW / YENİ					X	X		X	X					
MARBLE EXCLUSIVE / MERMER EXCLUSIVE	PATAGONIA	PATAGONIA NEW / YENİ						X		X	X					X
MARBLE EXCLUSIVE / MERMER EXCLUSIVE	QUARZITE J'ADORE	QUARZITE J'ADORE NEW / YENİ						X			X					X
MARBLE EXCLUSIVE / MERMER EXCLUSIVE	MARBLES	SEA NATURE	X	X												
MARBLE EXCLUSIVE / MERMER EXCLUSIVE	MARBLES	VERSAILLES						X		X						
MARBLE EXCLUSIVE / MERMER EXCLUSIVE	MARINA	MARINA NEW / YENİ						X			X					
MARBLE EXCLUSIVE / MERMER EXCLUSIVE	ALASKA WHITE	ALASKA WHITE NEW / YENİ						X			X					
MARBLE EXCLUSIVE / MERMER EXCLUSIVE	TIFFANY BLUE	TIFFANY BLUE NEW / YENİ						X								X
MARBLE EXCLUSIVE / MERMER EXCLUSIVE	NAMIBIA	NAMIBIA NEW / YENİ						X			X					
MARBLE TIMELESS / MERMER TIMELESS	MARBLES	PULPIS	X		X											
MARBLE TIMELESS / MERMER TIMELESS	FIORİ DI BOSCO	FIORİ DI BOSCO NEW / YENİ					X	X		X	X					
MARBLE TIMELESS / MERMER TIMELESS	DIAMOND COLLECTION	DENISE NEW / YENİ						X		X	X					
MARBLE TIMELESS / MERMER TIMELESS	MARBLES	TRANSLUCENT ONYX	X													

Size Table / Kalesinterflex

TİPOLOJİ TYPOLOGY	SERİ SERIES	ÜRÜN PRODUCT	100x300		120x360		160x320/162x323			162x323			162x323			OPENBOOK
			3MM	5MM	3MM	5MM	6MM			12MM			20MM			
			MAT / MATTE		MAT / MATTE		SOFT MAT / SOFT MATTE	PARLAK / POLISHED	SATEN / SATIN	SOFT MAT / SOFT MATTE	PARLAK / POLISHED	SATEN	SOFT MAT / SOFT MATTE	PARLAK / POLISHED	KAYA YÜZEY / ROCK SURFACE	
MARBLE TIMELESS / MERMER TIMELESS	MARBLES	TRAVERTINO			X											
MARBLE TIMELESS / MERMER TIMELESS	DIAMOND COLLECTION	CRYSTALLUS NEW / YENİ						X			X					
STONE / DOĞALTAŞ	MARBLES	LIMESTONE	X	X	X	X										
STONE / DOĞALTAŞ	C-STONE	C-STONE ANTHRACITE / C-STONE ANTRASİT	X	X	X	X										
STONE / DOĞALTAŞ	C-STONE	C-STONE BEIGE / C-STONE BEJ	X	X	X	X										
STONE / DOĞALTAŞ	C-STONE	C-STONE WHITE / C-STONE BEYAZ	X	X	X	X										
STONE / DOĞALTAŞ	C-STONE	C-STONE GREY / C-STONE GRİ	X	X	X	X										
STONE / DOĞALTAŞ	C-STONE	C-STONE BROWN / C-STONE KAHVE	X	X	X	X										
STONE / DOĞALTAŞ	KSF UPTOWN	UPTOWN DARK	X	X	X	X										
STONE / DOĞALTAŞ	KSF UPTOWN	UPTOWN LIGHT	X	X	X	X										
STONE / DOĞALTAŞ	NATURAL STONE	LECCESE DARK SAND	X	X	X	X										
STONE / DOĞALTAŞ	NATURAL STONE	LECCESE GREY	X	X												
STONE / DOĞALTAŞ	NATURAL STONE	LECCESE LIGHT SAND	X	X												
STONE / DOĞALTAŞ	NATURAL STONE	PIETRA BLUE	X	X	X	X										
STONE / DOĞALTAŞ	NATURAL STONE	PIETRA GREY	X	X												
STONE / DOĞALTAŞ	OCEAN	OCEAN BLACK	X	X												
STONE / DOĞALTAŞ	OCEAN	OCEAN WHITE	X	X												
STONE / DOĞALTAŞ	PIETRA BASALTINA	PIETRA BASALTINA	X									X		X		
STONE / DOĞALTAŞ	PIETRA DI CHATIL	PIETRA CHATILLONN	X	X												
STONE / DOĞALTAŞ	STONE GALLERY	QUARTZ ASH	X													
STONE / DOĞALTAŞ	CALCARIO COLLECTION	CALCARIO COLLECTION LINE GREIGE NEW / YENİ						X								
STONE / DOĞALTAŞ	CALCARIO COLLECTION	CALCARIO COLLECTION GREIGE NEW / YENİ	X	X				X			X				X	
STONE / DOĞALTAŞ	CALCARIO COLLECTION	CALCARIO COLLECTION LIGHT GREIGE	X	X				X			X				X	
STONE / DOĞALTAŞ	CALCARIO COLLECTION	CALCARIO COLLECTION LIGHT LINE GREIGE						X								
STONE / DOĞALTAŞ	STONELAND	PIETRA Dİ GRE BONE / KEMİK	X		X			X			X			X		
STONE / DOĞALTAŞ	STONELAND	PIETRA Dİ GRE GREY / GRİ	X		X			X			X			X		
STONE / DOĞALTAŞ	EARTH COLLECTION	TRAVERTINE IVORY NEW / YENİ						X			X					
STONE / DOĞALTAŞ	EARTH COLLECTION	TRAVERTINE SILVER NEW / YENİ						X			X					
STONE / DOĞALTAŞ	EARTH COLLECTION	RAPOLANO IVORY NEW / YENİ						X			X					
STONE / DOĞALTAŞ	EARTH COLLECTION	RAPOLANO SILVER NEW / YENİ						X			X					
STONE / DOĞALTAŞ	OMNITECH	CITYSCAPE NEW / YENİ									X					
METALLIC / METAL	METALLIC	LEDER BROWN / LEDER KAHVE	X													
METALLIC / METAL	METALLIC	METALLIC ANTHRACITE / METALİK ANTRASİT	X	X							X					
METALLIC / METAL	METALLIC	METALLIC CORAL / METALİK KIZIL	X	X												
METALLIC / METAL	RUSTONE	RUSTONE NEW / YENİ						X			X					
METALLIC / METAL	CORTEN	CORTEN NEW / YENİ						X								
METALLIC / METAL	FERRO	FERRO NEW / YENİ	X	X	X	X										
METALLIC / METAL	STEEL	STEEL NEW / YENİ	X		X											
CEMENT / ÇİMENTO	FACTORY	FACTORY BLACK	X													
CEMENT / ÇİMENTO	FACTORY	FACTORY GREIGE	X													
CEMENT / ÇİMENTO	FACTORY	FACTORY SILVER	X													
CEMENT / ÇİMENTO	HIGHWAY	HIGHWAY BONE / KEMİK			X						X					
CEMENT / ÇİMENTO	HUED	HUED ANTRASİT	X	X	X	X										
CEMENT / ÇİMENTO	HUED	HUED GREY / HUED GRİ	X	X	X	X										
CEMENT / ÇİMENTO	HUED	HUED DARK GREY / HUED KOYU GRİ	X	X	X	X										
CEMENT / ÇİMENTO	HUED	HUED OFF WHITE	X	X	X	X										

Size Table / Kalesinterflex

TİPOLOJİ TYPOLOGY	SERİ SERIES	ÜRÜN PRODUCT	100x300		120x360		160x320/162x323			162x323			162x323			OPENBOOK
			3MM	5MM	3MM	5MM	6MM			12MM			20MM			
			MAT / MATTE		MAT / MATTE		SOFT MAT / SOFT MATTE	PARLAK / POLISHED	SATEN / SATIN	SOFT MAT / SOFT MATTE	PARLAK / POLISHED	SATEN	SOFT MAT / SOFT MATTE	PARLAK / POLISHED	KAYA YÜZEY / ROCK SURFACE	
CEMENT / ÇİMENTO	LUXURY CEMENT	LUXURY CEMENT WHITE / LUXURY CEMENT BEYAZ NEW / YENİ	X	X	X	X	X				X					
CEMENT / ÇİMENTO	LUXURY CEMENT	LUXURY CEMENT ANTHI	X	X	X	X	X									
CEMENT / ÇİMENTO	LUXURY CEMENT	LUXURY CEMENT ANTHRACITE / LUXURY CEMENT ANTRASİT	X	X	X	X	X									
CEMENT / ÇİMENTO	LUXURY CEMENT	LUXURY CEMENT BEIGE / LUXURY CEMENT BEJ	X	X	X	X	X									
CEMENT / ÇİMENTO	LUXURY CEMENT	LUXURY CEMENT CEMENTO / LUXURY CEMENT ÇİMENTO	X	X	X	X	X				X					
CEMENT / ÇİMENTO	LUXURY CEMENT	LUXURY CEMENT GREY / LUXURY CEMENT GRİ	X	X	X	X	X									
CEMENT / ÇİMENTO	LUXURY CEMENT	LUXURY CEMENT TAUPE	X	X	X	X	X									
CEMENT / ÇİMENTO	LUXURY CEMENT	LUXURY CEMENT BROWN / LUXURY CEMENT KAHVE	X	X	X	X										
CEMENT / ÇİMENTO	LUXURY CEMENT	LUXURY CEMENT MINK / LUXURY CEMENT VİZON	X	X	X	X	X									
CEMENT / ÇİMENTO	ARCHE	ARCHE NEW / YENİ	X	X												
WOOD / AHŞAP	HOLLYWOOD	HOLLYWOOD BEIGE / HOLLYWOOD BEJ	X	X	X	X										
WOOD / AHŞAP	HOLLYWOOD	HOLLYWOOD BROWN / HOLLYWOOD KAHVE			X	X					X					
WOOD / AHŞAP	PLANK	PLANK 104	X	X												
WOOD / AHŞAP	PLANK	PLANK 110	X	X												
WOOD / AHŞAP	PLANK	PLANK 111	X	X												
WOOD / AHŞAP	PLANK	PLANK 114	X	X												
WOOD / AHŞAP	SHELL WOOD	SHELL WOOD DARK	X	X	X	X										
WOOD / AHŞAP	WOODLINE	WOODLINE WALNUT / WOODLINE CEVİZ	X	X												
WOOD / AHŞAP	WOODLINE	WOODLINE CHERRY / WOODLINE KIRAZ	X	X												
WOOD / AHŞAP	WOODLINE	WOODLINE OAK / WOODLINE MEŞE	X	X												
FLORAL	FLORAL	BLUE BLOSSOMS NEW / YENİ						X								
FLORAL	FLORAL	JASMINE NEW / YENİ						X								
GEOMETRIC / GEOMETRİK	GEOMETRIC / GEOMETRİK	LACE NEW / YENİ						X								
GEOMETRIC / GEOMETRİK	GEOMETRIC / GEOMETRİK	MOONDUST NEW / YENİ						X								
SOLID COLORS / DÜZ RENKLER	INNOVATION	INNOVATION CEMENT GREY / INNOVATION ÇİMENTO GRİ	X	X												
SOLID COLORS / DÜZ RENKLER	INNOVATION	INNOVATION BEIGE / INNOVATION BEJ	X	X	X											
SOLID COLORS / DÜZ RENKLER	INNOVATION	INNOVATION BEIGE GREY / INNOVATION BEJ GRİ	X	X	X											
SOLID COLORS / DÜZ RENKLER	INNOVATION	INNOVATION WHITE 2.0 / INNOVATION BEYAZ 2.0	X	X	X	X	X				X					
SOLID COLORS / DÜZ RENKLER	INNOVATION	INNOVATION PISTACHIO GREEN / INNOVATION FİSTİK YEŞİLİ	X													
SOLID COLORS / DÜZ RENKLER	INNOVATION	INNOVATION BROWN / INNOVATION KAHVE	X													
SOLID COLORS / DÜZ RENKLER	INNOVATION	INNOVATION MINK / INNOVATION KIZIL	X													
SOLID COLORS / DÜZ RENKLER	INNOVATION	INNOVATION DARK GREY / INNOVATION KOYU GRİ	X	X												
SOLID COLORS / DÜZ RENKLER	INNOVATION	INNOVATION BLUE / INNOVATION MAVİ	X													
SOLID COLORS / DÜZ RENKLER	INNOVATION	INNOVATION EXTRA WHITE / INNOVATION EXTRA BEYAZ	X	X	X	X					X	X				
SOLID COLORS / DÜZ RENKLER	INNOVATION	INNOVATION MEGA BLACK / INNOVATION MEGA SİYAH	X	X		X					X	X				
SOLID COLORS / DÜZ RENKLER	INNOVATION	INNOVATION BLACK / INNOVATION SİYAH	X	X		X					X					
SOLID COLORS / DÜZ RENKLER	INNOVATION	INNOVATION ORANGE / INNOVATION TURUNCU	X													

Kalesinterflex 100*300 - 120*360 3mm Technical Specifications

Kalesinterflex 100*300 - 120*360 3mm Teknik Tablo

	Norm - Test Method Norm - Test Methodu	Requirements for Nominal Size N Nominal Boyut N Gereklilikleri		KALE 1000x3000R (mm) Rectified / Rektifiyeli		KALE 1200x3600R (mm) Rectified / Rektifiyeli	
		N≥15cm		Matte Mat	Polished Parlatılmış	Matte Mat	Polished Parlatılmış
		% (for rectified) (Rektifiye edilmiş için)	mm (for rectified) (Rektifiye edilmiş için)				
Length and width Uzunluk ve genişlik	ISO 10545-2	± 0,3	± 1	Suitable Uygun	Suitable Uygun	Suitable Uygun	Suitable Uygun
Thickness Kalınlık		± 0,5	± 0,5	Suitable Uygun	Suitable Uygun	Suitable Uygun	Suitable Uygun
Straightness of sides Kenarların düzgünlüğü		± 0,3	± 0,8	Suitable Uygun	Suitable Uygun	Suitable Uygun	Suitable Uygun
Rectangularity (Measurement only on short edges when L/l ≥ 3) Gönyeden sapma (Sadece L/l ≥ 3 olduğunda ölçülür)		± 0,3	± 1,5	Suitable Uygun	Suitable Uygun	Suitable Uygun	Suitable Uygun
Surface flatness Yüzey düzgünlüğü		c.c. ± 0,4	c.c. ± 1,8	Suitable Uygun	Suitable Uygun	Suitable Uygun	Suitable Uygun
		e.c. ± 0,4	e.c. ± 1,8				
	w. ± 0,4	w. ± 1,8					
Water absorption Su emme	ISO 10545-3	Ev ≤ 0,5 % Individual max 0,6 % Ev ≤ 0,5 % tek olarak max 0,6 %		≤ 0,3 %	≤ 0,3 %	≤ 0,3 %	≤ 0,3 %
Breaking strength (Thickness < 7,5mm) Kırılma dayanımı (Kalınlık < 7,5mm)	ISO 10545-4	Not less than 700 N Daha az değil 700 N		≥ 700N	≥ 700N	≥ 700N	≥ 700N
Modulus of rupture Eğilme dayanımı		R ≥ 35 N/mm ²		≥ 45 N/mm ²	≥ 45 N/mm ²	≥ 45 N/mm ²	≥ 45 N/mm ²
Impact resistance, as coefficient of restitution Çarpma dayanımı	ISO 10545-5	Declared value Beyan edilen değer		≥ 55	≥ 55	≥ 55	≥ 55
Resistance to deep abrasion of unglazed tiles (removed volume) Derin aşınma	ISO 10545-6	≤ 175mm ³		Suitable Uygun	Suitable Uygun	Suitable Uygun	Suitable Uygun
Coefficient of thermal linear expansion Lineer ısı genleşme	ISO 10545-8	Declared value Beyan edilen değer		≤ 7 x 10 ⁻⁶	≤ 7 x 10 ⁻⁶	≤ 7 x 10 ⁻⁶	≤ 7 x 10 ⁻⁶
Thermal shock resistance Isıl şok dayanımı	ISO 10545-9	Pass according to EN ISO 10545-1 EN ISO 10545-1'e göre geçer		Resistant Dayanıklı	Resistant Dayanıklı	Resistant Dayanıklı	Resistant Dayanıklı
Moisture expansion Rutubet genleşmesi (in mm/m)	ISO 10545-10	Declared value Beyan edilen değer		≤ 0,01% (0,1mm/m)	≤ 0,01% (0,1mm/m)	≤ 0,01% (0,1mm/m)	≤ 0,01% (0,1mm/m)
Frost resistance Dona dayanım	ISO 10545-12	Pass according to EN ISO 10545-1 EN ISO 10545-1'e göre geçer		Resistant Dayanıklı	Resistant Dayanıklı	Resistant Dayanıklı	Resistant Dayanıklı
Bond strength / adhesion for improved cementitious adhesives Geliştirilmiş çimento esaslı yapıştırıcılar için bağlanma / yapışma mukavemeti	EN 1348	Declared value Beyan edilen değer		≥ 0,5 N/mm ²	≥ 0,5 N/mm ²	≥ 0,5 N/mm ²	≥ 0,5 N/mm ²
Reaction to fire Yangına tepki	-	A1 or / veya Afl		A1 without fiberglass Fiberglassız A1	A1 without fiberglass Fiberglassız A1	A1 without fiberglass Fiberglassız A1	A1 without fiberglass Fiberglassız A1
Resistance to household chemicals and swimming pool salts Ev ve havuz kimyasallarına dayanım		Minimum Class B Minimum sınıf B		A	A	A	A
Resistance to low concentrations of acids and alkalis Düşük konsantrasyonlu asit ve alkalilere dayanım	ISO 10545-13	Declared value Beyan edilen değer		LA	LA	LA	LA
Resistance to high concentrations of acids and alkalis Yüksek konsantrasyonlu asit ve alkalilere dayanım		Declared value Beyan edilen değer		HA	-	HA	-
Resistance to staining Lekelenme dayanımı	ISO 10545-14	Declared value Beyan edilen değer		5	5	5	5
Release of dangerous substances: cadmium (in mg/dm ²) and lead (in mg/dm ²) Tehlikeli madde salınımı: kadmiyum (mg/dm ²) ve kurşun (mg/dm ²)	ISO 10545-15	Declared value Beyan edilen değer		≤ 0,01 mg/dm ² Cd ≤ 0,1 mg/dm ² Pb	≤ 0,01 mg/dm ² Cd ≤ 0,1 mg/dm ² Pb	≤ 0,01 mg/dm ² Cd ≤ 0,1 mg/dm ² Pb	≤ 0,01 mg/dm ² Cd ≤ 0,1 mg/dm ² Pb

Kalesinterflex 100*300 - 120*360 5mm Technical Specifications

Kalesinterflex 100*300 - 120*360 5mm Teknik Tablo

	Norm - Test Method Norm - Test Methodu	Requirements for Nominal Size N Nominal Boyut N Gereklikleri		KALE 1000x3000R (mm) Rectified / Rektifiyeli		KALE 1200x3600R (mm) Rectified / Rektifiyeli	
		N ≥ 15cm		Matte Mat	Polished Parlatılmış	Matte Mat	Polished Parlatılmış
		% (for rectified) (Rektifiye edilmiş için)	mm (for rectified) (Rektifiye edilmiş için)				
Length and width Uzunluk ve genişlik	ISO 10545-2	± 0,3	± 1	Suitable Uygun	Suitable Uygun	Suitable Uygun	Suitable Uygun
Thickness Kalınlık		± 0,5	± 0,5	Suitable Uygun	Suitable Uygun	Suitable Uygun	Suitable Uygun
Straightness of sides Kenarların düzgünlüğü		± 0,3	± 0,8	Suitable Uygun	Suitable Uygun	Suitable Uygun	Suitable Uygun
Rectangularity (Measurement only on short edges when L/l ≥ 3) Gönyeden sapma (Sadece L/l ≥ 3 olduğunda ölçülür)		± 0,3	± 1,5	Suitable Uygun	Suitable Uygun	Suitable Uygun	Suitable Uygun
Surface flatness Yüzey düzgünlüğü		c.c. ± 0,4	c.c. ± 1,8	Suitable Uygun	Suitable Uygun	Suitable Uygun	Suitable Uygun
		e.c. ± 0,4	e.c. ± 1,8				
	w. ± 0,4	w. ± 1,8					
Water absorption Su emme	ISO 10545-3	Ev ≤ 0,5 % Individual max 0,6 % Ev ≤ 0,5 % tek olarak max 0,6 %		≤ 0,3 %	≤ 0,3 %	≤ 0,3 %	≤ 0,3 %
Breaking strength (Thickness < 7,5mm) Kırılma dayanımı (Kalınlık < 7,5mm)	ISO 10545-4	Not less than 700 N		≥ 700N	≥ 700N	≥ 700N	≥ 700N
Modulus of rupture Eğilme dayanımı		R ≥ 35 N/mm ²		≥ 45 N/mm ²	≥ 45 N/mm ²	≥ 45 N/mm ²	≥ 45 N/mm ²
Impact resistance, as coefficient of restitution Çarpma dayanımı	ISO 10545-5	Declared value Beyan edilen değer		≥ 55	≥ 55	≥ 55	≥ 55
Resistance to deep abrasion of unglazed tiles (removed volume) Derin aşınma	ISO 10545-6	≤ 175mm ³		Suitable Uygun	Suitable Uygun	Suitable Uygun	Suitable Uygun
Coefficient of thermal linear expansion Lineer ısı genleşme	ISO 10545-8	Declared value Beyan edilen değer		≤ 7 x 10 ⁻⁶	≤ 7 x 10 ⁻⁶	≤ 7 x 10 ⁻⁶	≤ 7 x 10 ⁻⁶
Thermal shock resistance Isıl şok dayanımı	ISO 10545-9	Pass according to EN ISO 10545-1 EN ISO 10545-1'e göre geçer		Resistant Dayanıklı	Resistant Dayanıklı	Resistant Dayanıklı	Resistant Dayanıklı
Moisture expansion Rutubet genleşmesi (in mm/m)	ISO 10545-10	Declared value Beyan edilen değer		≤ 0,01% (0,1mm/m)	≤ 0,01% (0,1mm/m)	≤ 0,01% (0,1mm/m)	≤ 0,01% (0,1mm/m)
Frost resistance Dona dayanım	ISO 10545-12	Pass according to EN ISO 10545-1 EN ISO 10545-1'e göre geçer		Resistant Dayanıklı	Resistant Dayanıklı	Resistant Dayanıklı	Resistant Dayanıklı
Bond strength / adhesion for improved cementitious adhesives Geliştirilmiş çimento esaslı yapıştırıcılar için bağlanma / yapışma mukavemeti	EN 1348	Declared value Beyan edilen değer		≥ 0,5 N/mm ²	≥ 0,5 N/mm ²	≥ 0,5 N/mm ²	≥ 0,5 N/mm ²
Reaction to fire Yangına tepki	-	A1 or Af1		A1 without fiberglass	A1 without fiberglass	A1 without fiberglass	A1 without fiberglass
Resistance to household chemicals and swimming pool salts Ev ve havuz kimyasallarına dayanım		Minimum Class B Minimum sınıf B		A	A	A	A
Resistance to low concentrations of acids and alkalis Düşük konsantrasyonlu asit ve alkalilere dayanım	ISO 10545-13	Declared value Beyan edilen değer		LA	LA	LA	LA
Resistance to high concentrations of acids and alkalis Yüksek konsantrasyonlu asit ve alkalilere dayanım		Declared value Beyan edilen değer		HA	-	HA	-
Resistance to staining Lekelenme dayanımı	ISO 10545-14	Declared value Beyan edilen değer		5	5	5	5
Release of dangerous substances: cadmium (in mg/dm ²) and lead (in mg/dm ²) Tehlikeli madde salınımı: kadmiyum (mg/dm ²) ve kurşun (mg/dm ²)	ISO 10545-15	Declared value Beyan edilen değer		≤ 0,01 mg/dm ² Cd ≤ 0,1 mg/dm ² Pb	≤ 0,01 mg/dm ² Cd ≤ 0,1 mg/dm ² Pb	≤ 0,01 mg/dm ² Cd ≤ 0,1 mg/dm ² Pb	≤ 0,01 mg/dm ² Cd ≤ 0,1 mg/dm ² Pb

Kalesinterflex 160*320 - 162x323 6mm-12mm Technical Table

Kalesinterflex 160*320 - 162x323 6mm-12mm Teknik Tablo

	Norm - Test Method Norm - Test Methodu	Requirements for Nominal Size N Nominal Boyut N Gereklilikleri		KALE 1620X3230 (mm) Non-rectified / Rektifiyesiz		KALE 1600X3200R (mm) Rectified / Rektifiyeli	
		N≥15cm		Matte Mat	Polished Parlatılmış	Matte Mat	Polished Parlatılmış
		% (for rectified) (Rektifiye edilmiş için)	mm (for rectified) (Rektifiye edilmiş için)				
Length and width Uzunluk ve genişlik	ISO 10545-2	± 0,3	± 1	N.A.	N.A.	Suitable Uygun	Suitable Uygun
Thickness Kalınlık		± 0,5	± 0,5	N.A.	N.A.	Suitable Uygun	Suitable Uygun
Straightness of sides Kenarların düzgünlüğü		± 0,3	± 0,8	N.A.	N.A.	Suitable Uygun	Suitable Uygun
Rectangularity (Measurement only on short edges when L/l ≥ 3) Gönyeden sapma (Sadece L/l ≥ 3 olduğunda ölçülür)		± 0,3	± 1,5	N.A.	N.A.	Suitable Uygun	Suitable Uygun
Surface flatness Yüzey düzgünlüğü		c.c. ± 0,4	c.c. ± 1,8	N.A.	N.A.	Suitable Uygun	Suitable Uygun
		e.c. ± 0,4	e.c. ± 1,8				
		w. ± 0,4	w. ± 1,8				
Water absorption Su emme	ISO 10545-3	Ev ≤ 0,5% Individual max 0,6% Ev ≤ 0,5% tek olarak max 0,6%		≤ 0,1 %	≤ 0,1 %	≤ 0,1 %	≤ 0,1 %
Breaking strength Kırılma dayanımı	ISO 10545-4	for thickness / kalınlık < 7,5mm S ≥ 700 N for thickness/kalınlık ≥ 7,5mm S ≥ 1300 N		6mm -> S ≥ 700N 12mm -> S ≥ 4000N	6mm -> S ≥ 700N 12mm -> S ≥ 4000N	6mm -> S ≥ 700N 12mm -> S ≥ 4000N	6mm -> S ≥ 700N 12mm -> S ≥ 4000N
Modulus of rupture Eğilme dayanımı		R ≥ 35 N/mm ²		6mm -> R ≥ 35 N/mm ² 12mm -> R ≥ 45 N/mm ²	6mm -> R ≥ 35 N/mm ² 12mm -> R ≥ 45 N/mm ²	6mm -> R ≥ 35 N/mm ² 12mm -> R ≥ 45 N/mm ²	6mm -> R ≥ 35 N/mm ² 12mm -> R ≥ 45 N/mm ²
Impact resistance, as coefficient of restitution Çarpma dayanımı	ISO 10545-5	Declared value Beyan edilen değer		≥ 55	≥ 55	≥ 55	≥ 55
Resistance to deep abrasion of unglazed tiles (removed volume) Derin aşınma	ISO 10545-6	≤ 175mm ³		Suitable Uygun	Suitable Uygun	Suitable Uygun	Suitable Uygun
Coefficient of thermal linear expansion Lineer ısı genleşme	ISO 10545-8	Declared value Beyan edilen değer		≤ 7 MK-1	≤ 7 MK-1	≤ 7 MK-1	≤ 7 MK-1
Thermal shock resistance Isıl şok dayanımı	ISO 10545-9	Pass according to EN ISO 10545-1 EN ISO 10545-1'e göre geçer		Resistant Dayanıklı	Resistant Dayanıklı	Resistant Dayanıklı	Resistant Dayanıklı
Moisture expansion Rutubet genleşmesi (in mm/m)	ISO 10545-10	Declared value Beyan edilen değer		≤ 0,01% (0,1mm/m)	≤ 0,01% (0,1mm/m)	≤ 0,01% (0,1mm/m)	≤ 0,01% (0,1mm/m)
Frost resistance Dona dayanım	ISO 10545-12	Pass according to EN ISO 10545-1 EN ISO 10545-1'e göre geçer		Resistant Dayanıklı	Resistant Dayanıklı	Resistant Dayanıklı	Resistant Dayanıklı
Bond strength / adhesion for improved cementitious adhesives Geliştirilmiş çimento esaslı yapıştırıcılar için bağlanma / yapışma mukavemeti	EN 1348	Declared value Beyan edilen değer		≥ 0,5 N/mm ²	≥ 0,5 N/mm ²	≥ 0,5 N/mm ²	≥ 0,5 N/mm ²
Reaction to fire Yangına tepki	-	A1 or Afl		A1 without fiberglass	A1 without fiberglass	A1 without fiberglass	A1 without fiberglass
Resistance to household chemicals and swimming pool salts Ev ve havuz kimyasallarına dayanım	ISO 10545-13	Minimum Class B Minimum sınıf B		A	A	A	A
Resistance to low concentrations of acids and alkalis Düşük konsantrasyonlu asit ve alkalilere dayanım		Declared value Beyan edilen değer		LA	LA	LA	LA
Resistance to high concentrations of acids and alkalis Yüksek konsantrasyonlu asit ve alkalilere dayanım		Declared value Beyan edilen değer		HA	-	HA	-
Resistance to staining Lekelenme dayanımı	ISO 10545-14	Declared value Beyan edilen değer		5	5	5	5
Release of dangerous substances: cadmium (in mg/dm ²) and lead (in mg/dm ²) Tehlikeli madde salınımı: kadmium (mg/dm ²) ve kurşun (mg/dm ²)	ISO 10545-15	Declared value Beyan edilen değer		≤ 0,01 mg/dm ² Cd ≤ 0,1 mg/dm ² Pb	≤ 0,01 mg/dm ² Cd ≤ 0,1 mg/dm ² Pb	≤ 0,01 mg/dm ² Cd ≤ 0,1 mg/dm ² Pb	≤ 0,01 mg/dm ² Cd ≤ 0,1 mg/dm ² Pb

100*300-120*360 Packaging and Shipping Details

100*300-120*360 Paketleme ve Gönderim Detayı

CRATE SIZE ÜRÜN EBADI cm	CRATE SIZE SANDIK EBADI cm	PRODUCT GROUP ÜRÜN GRUBU	kg/m ²	PIECE ADET/m ²	EMPTY CRATE BOŞ SANDIK kg	CRATE DETAILS SANDIK DETAY			TRUCK TIR			20" CONTAINER 20 LİK KONTEYNER			40" CONTAINER 40 LİK KONTEYNER		
						PRODUCT QUANTITY ÜRÜN ADET	PRODUCT ÜRÜN m ²	KG (PRODUCT+CRATE) (ÜRÜN+SANDIK)	PRODUCT-CRATE SANDIK ADET	m ²	KG (PRODUCT+CRATE) (ÜRÜN+SANDIK)	PRODUCT-CRATE SANDIK ADET	m ²	KG (PRODUCT+CRATE) (ÜRÜN+SANDIK)	PRODUCT-CRATE SANDIK ADET	m ²	KG (PRODUCT+CRATE) (ÜRÜN+SANDIK)
100x300cm	114x317x40	3MM PLAİN	7	3	180	50	150,00	1.365	19	2.850	25.935	10	1.500	13.650	19	2.850	25.935
		5MM PLAİN	11,66	3	180	35	105,00	1.404	18	1.890	25.277	10	1.050	14.043	18	1.890	25.277
		6MM PLAİN	14	3	180	15	45,00	810	18	810	14.580	10	450	8.100	18	810	14.580
		3MM FİT	8	3	180	45	135,00	1.260	20	2.700	25.200	10	1.350	12.600	19	2.565	23.940
		5MM FİT	12,5	3	180	32	96,00	1.380	19	1.824	26.220	10	960	13.800	18	1.728	24.840
		6MM FİT	15	3	180	26	78,00	1.350	19	1.482	25.650	10	780	13.500	18	1.404	24.300
100x150 CM	113x163X40	3MM PLAİN	7	1,5	90	50	75,00	615	36	2.700	22.140	30	2.250	18.450	36	2.700	22.140
		5MM PLAİN	11,66	1,5	90	35	52,50	702	36	1.890	25.277	30	1.575	21.065	36	1.890	25.277
		6MM PLAİN	14	1,5	90	30	45,00	720	36	1.620	25.920	30	1.350	21.600	36	1.620	25.920
		3MM FİT	8	1,5	90	45	67,50	630	36	2.430	22.680	30	2.025	18.900	36	2.430	22.680
		5MM FİT	12,5	1,5	90	32	48,00	690	36	1.728	24.840	30	1.440	20.700	36	1.728	24.840
		6MM FİT	15	1,5	90	26	39,00	675	36	1.404	24.300	30	1.170	20.250	36	1.404	24.300
100x100 CM	113x113X40	3MM PLAİN	7	1	60	50	50,00	410	50	2.500	20.500	50	2.500	20.500	50	2.500	20.500
		5MM PLAİN	11,66	1	60	35	35,00	468	50	1.750	23.405	50	1.750	23.405	50	1.750	23.405
		6MM PLAİN	14	1	60	18	18,00	312	50	900	15.600	50	900	15.600	50	900	15.600
		3MM FİT	8	1	60	45	45,00	420	50	2.250	21.000	50	2.250	21.000	50	2.250	21.000
		5MM FİT	12,5	1	60	32	32,00	460	50	1.600	23.000	50	1.600	23.000	50	1.600	23.000
		6MM FİT	15	1	60	26	26,00	450	50	1.300	22.500	50	1.300	22.500	50	1.300	22.500
50x300 CM	114x317X40	3MM PLAİN	7	1,5	180	100	150,00	1.230	19	2.850	23.370	10	1.500	12.300	19	2.850	23.370
		5MM PLAİN	11,66	1,5	180	70	105,00	1.404	18	1.890	25.277	10	1.050	14.043	18	1.890	25.277
		6MM PLAİN	14	1,5	180	60	90,00	1.440	19	1.710	27.360	10	900	14.400	18	1.620	25.920
		3MM FİT	8	1,5	180	90	135,00	1.260	20	2.700	25.200	10	1.350	12.600	19	2.565	23.940
		5MM FİT	12,5	1,5	180	64	96,00	1.380	19	1.824	26.220	10	960	13.800	18	1.728	24.840
		6MM FİT	15	1,5	180	52	78,00	1.350	19	1.482	25.650	10	780	13.500	18	1.404	24.300
50x150 CM	113x163X40	3MM PLAİN	7	0,75	90	100	75,00	615	36	2.700	22.140	30	2.250	18.450	36	2.700	22.140
		5MM PLAİN	11,66	0,75	90	70	52,50	702	36	1.890	25.277	30	1.575	21.065	36	1.890	25.277
		6MM PLAİN	14	0,75	90	60	45,00	720	36	1.620	25.920	30	1.350	21.600	36	1.620	25.920
		3MM FİT	8	0,75	90	90	67,50	630	36	2.430	22.680	30	2.025	18.900	36	2.430	22.680
		5MM FİT	12,5	0,75	90	64	48,00	690	36	1.728	24.840	30	1.440	20.700	36	1.728	24.840
		6MM FİT	15	0,75	90	52	39,00	675	36	1.404	24.300	30	1.170	20.250	36	1.404	24.300
50x100 CM	113x113X40	3MM PLAİN	7	0,5	60	100	50,00	410	50	2.500	20.500	50	2.500	20.500	50	2.500	20.500
		5MM PLAİN	11,66	0,5	60	70	35,00	468	50	1.750	23.405	50	1.750	23.405	50	1.750	23.405
		6MM PLAİN	14	0,5	60	60	30,00	480	50	1.500	24.000	50	1.500	24.000	50	1.500	24.000
		3MM FİT	8	0,5	60	90	45,00	420	50	2.250	21.000	50	2.250	21.000	50	2.250	21.000
		5MM FİT	12,5	0,5	60	64	32,00	460	50	1.600	23.000	50	1.600	23.000	50	1.600	23.000
		6MM FİT	15	0,5	60	52	26,00	450	50	1.300	22.500	50	1.300	22.500	50	1.300	22.500

100*300-120*360 Packaging and Shipping Details

100*300-120*360 Paketleme ve Gönderim Detayı

CRATE SIZE ÜRÜN EBADI cm	CRATE SIZE SANDIK EBADI cm	PRODUCT GROUP ÜRÜN GRUBU	kg/m ²	PIECE ADET/m ²	EMPTY CRATE BOŞ SANDIK kg	CRATE DETAILS SANDIK DETAY			TRUCK TIR			20" CONTAINER 20 LİK KONTEYNER			40" CONTAINER 40 LİK KONTEYNER		
						PRODUCT QUANTITY ÜRÜN ADET	PRODUCT ÜRÜN m ²	KG (PRODUCT+CRATE) (ÜRÜN+SANDIK)	PRODUCT-CRATE SANDIK ADET	m ²	KG (PRODUCT+CRATE) (ÜRÜN+SANDIK)	PRODUCT-CRATE SANDIK ADET	m ²	KG (PRODUCT+CRATE) (ÜRÜN+SANDIK)	PRODUCT-CRATE SANDIK ADET	m ²	KG (PRODUCT+CRATE) (ÜRÜN+SANDIK)
120x360 CM	134x377x34	3MM PLAİN	7	4,32	220	40	172,80	1.430	15	2.592	21.444	5	864	7.148	15	2.592	21.444
		5MM PLAİN	11,66	4,32	220	27	116,64	1.580	15	1.750	23.700	5	583	7.900	15	1.750	23.700
		6MM PLAİN	14	4,32	220	22	95,04	1.551	15	1.426	23.258	5	475	7.753	15	1.426	23.258
		3MM FİT	8	4,32	220	35	151,20	1.430	15	2.268	21.444	5	756	7.148	15	2.268	21.444
		5MM FİT	12,5	4,32	220	23	99,36	1.462	15	1.490	21.930	5	497	7.310	15	1.490	21.930
		6MM FİT	15	4,32	220	20	86,40	1.516	15	1.296	22.740	5	432	7.580	15	1.296	22.740
120x180 CM	134x193x34	3MM PLAİN	7	2,16	110	40	86,40	715	30	2.592	21.444	20	1.728	14.296	30	2.592	21.444
		5MM PLAİN	11,66	2,16	110	27	58,32	790	30	1.750	23.700	20	1.166	15.800	30	1.750	23.700
		6MM PLAİN	14	2,16	110	22	47,52	775	30	1.426	23.258	20	950	15.506	30	1.426	23.258
		3MM FİT	8	2,16	110	35	75,60	715	30	2.268	21.444	20	1.512	14.296	30	2.268	21.444
		5MM FİT	12,5	2,16	110	23	49,68	731	30	1.490	21.930	20	994	14.620	30	1.490	21.930
		6MM FİT	15	2,16	110	20	43,20	758	30	1.296	22.740	20	864	15.160	30	1.296	22.740
120x120 CM	134x134x34	3MM PLAİN	7	1,44	80	40	57,60	483	50	2.880	24.160	20	1.152	9.664	45	2.592	21.744
		5MM PLAİN	11,66	1,44	80	27	38,88	533	50	1.944	26.667	20	778	10.667	45	1.750	24.000
		6MM PLAİN	14	1,44	80	22	31,68	524	50	1.584	26.176	20	634	10.470	45	1.426	23.558
		3MM FİT	8	1,44	80	35	50,40	483	50	2.520	24.160	20	1.008	9.664	45	2.268	21.744
		5MM FİT	12,5	1,44	80	23	33,12	494	50	1.656	24.700	20	662	9.880	45	1.490	22.230
		6MM FİT	15	1,44	80	20	28,80	512	50	1.440	25.600	20	576	10.240	45	1.296	23.040
60x360 CM	134x377x34	3MM PLAİN	7	2,16	220	80	172,80	1.430	15	2.592	21.444	5	864	7.148	15	2.592	21.444
		5MM PLAİN	11,66	2,16	220	54	116,64	1.580	15	1.750	23.700	5	583	7.900	15	1.750	23.700
		6MM PLAİN	14	2,16	220	44	95,04	1.551	15	1.426	23.258	5	475	7.753	15	1.426	23.258
		3MM FİT	8	2,16	220	70	151,20	1.430	15	2.268	21.444	5	756	7.148	15	2.268	21.444
		5MM FİT	12,5	2,16	220	46	99,36	1.462	15	1.490	21.930	5	497	7.310	15	1.490	21.930
		6MM FİT	15	2,16	220	40	86,40	1.516	15	1.296	22.740	5	432	7.580	15	1.296	22.740
60x180 CM	134x193x34	3MM PLAİN	7	1,08	110	80	86,40	715	30	2.592	21.444	20	1.728	14.296	30	2.592	21.444
		5MM PLAİN	11,66	1,08	110	54	58,32	790	30	1.750	23.700	20	1.166	15.800	30	1.750	23.700
		6MM PLAİN	14	1,08	110	44	47,52	775	30	1.426	23.258	20	950	15.506	30	1.426	23.258
		3MM FİT	8	1,08	110	70	75,60	715	30	2.268	21.444	20	1.512	14.296	30	2.268	21.444
		5MM FİT	12,5	1,08	110	46	49,68	731	30	1.490	21.930	20	994	14.620	30	1.490	21.930
		6MM FİT	15	1,08	110	40	43,20	758	30	1.296	22.740	20	864	15.160	30	1.296	22.740
60x120 CM	134x134x34	3MM PLAİN	7	0,72	80	80	57,60	483	50	2.880	24.160	20	1.152	9.664	45	2.592	21.744
		5MM PLAİN	11,66	0,72	80	54	38,88	533	50	1.944	26.667	20	778	10.667	45	1.750	24.000
		6MM PLAİN	14	0,72	80	44	31,68	524	50	1.584	26.176	20	634	10.470	45	1.426	23.558
		3MM FİT	8	0,72	80	70	50,40	483	50	2.520	24.160	20	1.008	9.664	45	2.268	21.744
		5MM FİT	12,5	0,72	80	66	47,52	674	50	1.656	24.700	20	662	9.880	45	1.490	22.230
		6MM FİT	15	0,72	80	40	28,80	512	50	1.440	25.600	20	576	10.240	45	1.296	23.040

Packaging and Shipping Details

Paketleme ve Gönderim Detayları

Packaging And Packages

Ambalaj ve Paketler

Kalesinterflex 6mm, 12mm and 20mm thick full-length 1620x3230mm slabs are vertically packed on metal "A-Frame".

Kalesinterflex 6mm, 12mm ve 20mm tam boy 1620x3230mm plakalar, metal "A Frame" üzerinde dikey olarak ambalajlanır.

A-Frame

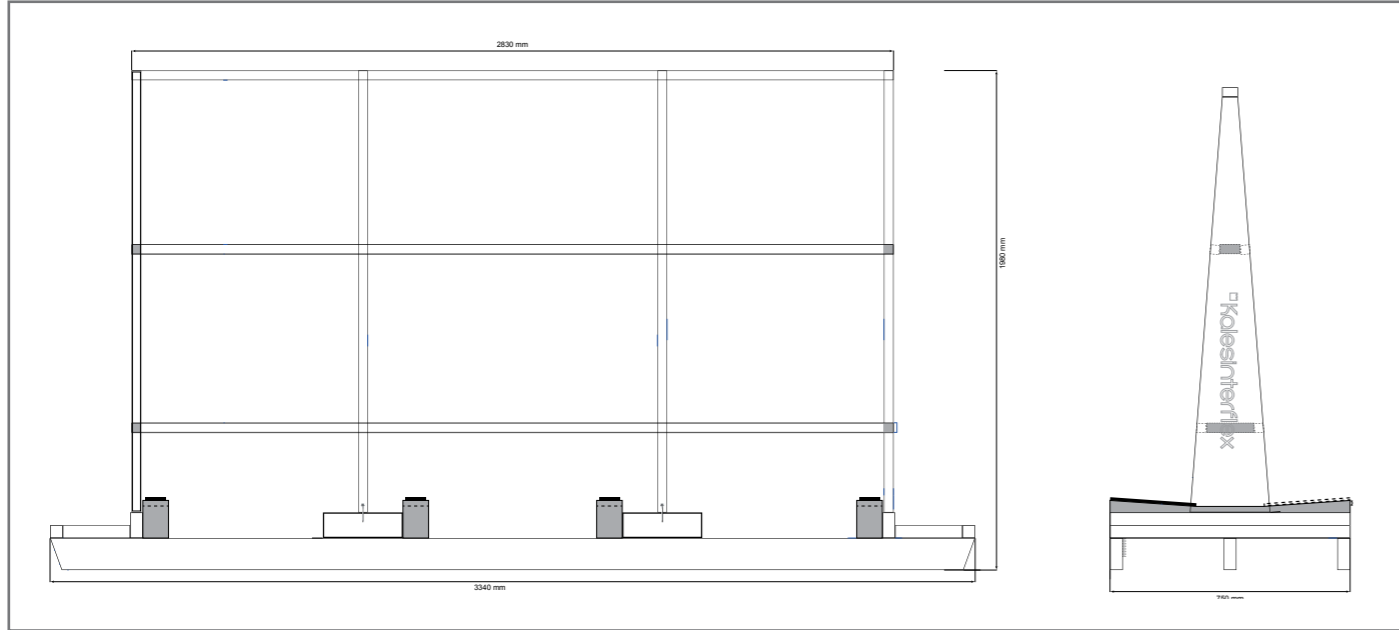

162x323cm Quantity, Weight and Size Information of A-Frame;

162x323cm A-Frame Metraj, Kilogram ve Ölçü Bilgileri;

Format /mm (vertical stacking) (dikey istifleme)	Thickness Kalınlık (mm)	Pcs for A-Frame (Pcs / A-Frame) A-Frame için adet (Adet / A-Frame)	m ² for A-Frame A-Frame için m ²	Weight (kg) for A-Frame (A-Frame is included.) Ağırlık (kg) A-Frame için (A-Frame dahil)	Full Size of A-Frame A-Frame'in Tam Boyutu (cm)
Kalesinterflex 6mm Full Length* Tam Boy* 1620x3230mm 63.7"x127.7"	6	44	230.12	3420	334x75x198h
Kalesinterflex 12mm Full Length* Tam Boy* 1620x3230mm 63.7"x127.7"	12	24	125.52	3782	334x75x198h
Kalesinterflex 20mm Full Length* Tam Boy* 1620x3230mm 63.7"x127.7"	20	12	62.76	3173	334x75x198h

*"Furnace Slab" having untrimmed format. 5,23 m²/piece-Empty A-Frame 130kg (metal)

* Tıraşlanmamış "fırın çıkışı" formatı plaka. 5.23m²/adet - Boş A-Frame 130kg (metal)

160x320cm Quantity, Weight and Size Information of A-Frame;

160x320cm A-Frame Metraj, Kilogram ve Ölçü Bilgileri;

Format /mm (vertical stacking) (dikey istifleme)	Thickness Kalınlık (mm)	Pcs for A-Frame (Pcs / A-Frame) A-Frame için adet (Adet / A-Frame)	m ² for A-Frame A-Frame için m ²	Weight (kg) for A-Frame (A-Frame is included.) Ağırlık (kg) A-Frame için (A-Frame dahil)	Full Size of A-Frame A-Frame'in Tam Boyutu (cm)
Kalesinterflex 6mm Full Length* Tam Boy* 1600x3200mm 63.0"x126.0"	6	44	225.28	3348	334x75x198h
Kalesinterflex 12mm Full Length* Tam Boy* 1600x3200mm 63.0"x126.0"	12	24	122.88	3703	334x75x198h
Kalesinterflex 20mm Full Length* Tam Boy* 1600x3200mm 63.0"x126.0"	20	12	61.44	3108	334x75x198h

162x323cm Information Regarding the A-Frame Carrying Capacities of Containers and Trucks

162x323cm Konteyner ve Tır A-Frame Kapasite Bilgileri

Container Loading with A-Frame / A-Frame Konteyner Yükleme									
(1620x3230mm (63.7"x127.7"))									
Container Type Konteyner Tipi	20" Container Konteyner			40" Container Konteyner			Truck / Tır (13.60m)		
The Thickness of the Slab Slab Kalınlık (mm)	6	12	20	6	12	20	6	12	20
A-Frame That Can Be Loaded (Pieces) Yüklenebilir A-Frame (Adet)	3	3	3	7	7	7	7	7	7
Slabs That Can Be Loaded (Pcs) Yüklenebilir Slab (Adet)	132	72	36	308	168	84	308	168	84
Loadable Area Yüklenebilir (m ²)	690.36	376.56	188.28	1610.84	878.64	439.32	1610.84	878.64	439.32
Maximum Total Weight Azami toplam ağırlık (kg)	10.260	11.346	9.519	23.940	26.474	22.212	23.940	26.474	22.212

* Empty weight of A-Frame 121kg (metal)

* Bos A-Frame ağırlığı 130kg (metal)

160x320cm Information Regarding the A-Frame Carrying Capacities of Containers and Trucks

160x320cm Konteyner ve Tır A-Frame Kapasite Bilgileri

Container Loading with A-Frame / A-Frame Konteyner Yükleme									
(1600x3200mm (63.0"x126.0"))									
Container Type Konteyner Tipi	20" Container Konteyner			40" Container Konteyner			Truck / Tır (13.60m)		
The Thickness of the Slab Slab Kalınlık (mm)	6	12	20	6	12	20	6	12	20
A-Frame That Can Be Loaded (Pieces) Yüklenebilir A-Frame (Adet)	3	3	3	7	7	7	7	7	7
Slabs That Can Be Loaded (Pcs) Yüklenebilir Slab (Adet)	132	72	36	308	168	84	308	168	84
Loadable Area Yüklenebilir (m ²)	675.84	368.64	184.32	1576.96	860.16	430.08	1576.96	860.16	430.08
Maximum Total Weight Azami toplam ağırlık (kg)	10.044	11.109	9.324	23.436	25.921	21.756	23.436	25.921	21.756

1. Carrying and Storing

1. Taşıma ve Depolama

Kalesinterflex 1620x3230mm slabs should be carried in safe conditions to protect their original appearance and prevent accidental damage. It is recommended to be careful and make sure that the carrying area is closed to pedestrians while the product is carried.

Kalesinterflex 1620x3230mm plakaların taşınması, malzemenin orijinal görünümünü korumak ve kazara kırılmalarını önlemek için güvenli koşullarda gerçekleştirilmelidir. Malzemenin taşınması aşamalarında, alanın yayalara kapalı olduğundan emin olarak dikkat gösterilmesi tavsiye edilir.

1.1. Carrying A-Frame with a Forklift

1.1. Forklift ile A-Frame Taşıma

A-Frame should be symmetrically loaded before carrying to prevent balance problems. Before carrying, the operator should always check that the slabs are fixed to A-Frame with special tapes. It is recommended to be careful while carrying the slabs loaded on the A-Frame since they are not protected at the points corresponding to the outer edges.

A-Frame's are equipped with two gripping points to be carried with a forklift:

The distance between the forklift's forks for "A" front gripping point is 740mm. The distance between the forks for the "B" lateral gripping point is 500mm.

If both A and B lateral loading points are to be used, a forklift that has 8000kg maximum load capacity is recommended. The Kalesinterflex porcelain slabs loaded on the A-Frame in the warehouse or near the transformer should be preferably carried by using the "A" front gripping point. In other words, the process should be carried out by using a 3230mm A-Frame, to which the products are to be fixed and a forklift that has 1200mm long forks at least, and a 5000-8000kg load capacity. If the 'B' gripping point is to be used, a forklift that has an 8000kg load capacity and at least 2800mm forks should be used. It should be ensured that the load does not move on the forks. While loading and unloading trucks and containers, fix A-Frame with the help of the two "A" and "B" gripping points in the way specified in the following paragraphs, respectively. While loading / unloading the trucks and containers and carrying even a single slab, fix the slabs to A-Frame with cloth or plastic tapes/straps. Metal chains should not be used at this stage.

Before the slabs are taken out from the A-Frame, it is necessary to place it on a flat surface having no defects that may cause the slab (s) to fall.

Taşımadan önce, dengesizlik problemlerini önlemek için A-Frame simetrik olarak yüklenmelidir. Operatör taşımaya geçmeden önce, plakaların özel bantlarla A-Frame sabitlenmiş olduklarını daima kontrol etmelidir. A-Frame üzerine yüklenen plakalar dış kenarlara karşılık gelen noktalarda korunmadığından, malzemeyi taşıma aşamaları esnasında dikkatli olunması önerilir.

A-Frame'ler forklift ile taşıma için iki kavrama noktası ile donatılmıştır:

"A" ön kavrama noktası; En az 740mm forklift bıçak aralığı mesafesi. "B" yanal kavrama noktası bıçak aralığı mesafesi 500mm'dir.

Eğer A ve B yan al yüklem e noktalarından her ikisi de kullanılacak ise max. 8000kg kapasiteli forklift tercih edilmesi önerilir. Depodaki veya transformatör yakınındaki A-Frame üzerine yüklenmiş Kalesinterflex porselen plakaların taşınması, tercihen ön kavrama noktası "A" kullanılarak, yani A-Frame 3230mm tarafından en az 1200mm uzunluğunda çatallar ve en az 5000-8000kg kapasiteye sahip bir forklift kullanmak suretiyle sabitleyerek gerçekleştirilmelidir. Kavrama noktası 'B' kullanılıyorsa, en az 2800mm uzunluğunda çatallara sahip 8000kg kapasiteli bir forklift kullanılmalıdır.

Yükün çatallar üzerinde sabit durduğundan ve sallanmadığından emin olunmalıdır. Kamyonlardan ve konteynerlerden yükleme ve boşaltma aşamalarında, sırasıyla aşağıdaki paragraflarda belirtilen "A" ve "B" iki kavrama noktası yardımıyla A-Frame sabitleyin. Yüklerken / boşaltırken ve ardından tek bir plakayı bile taşıırken, bez veya plastik bantlar / kayışlar kullanarak plakayı A-Frame sabitleyin. Bu aşamada metal zincirler kullanılmamalıdır.

Plakalar A-Frame sabitleyen bantlardan serbest bırakılmadan önce, A-Frame, plakanın / plakaların düşmesine neden olabilecek zemin seviye farklılıklarının olmadığı düz bir yüzeye yerleştirildiğinden emin olunması gerekmektedir.

Forklift with 5000 weight (kg)
capacity to carry from direction B

A yönünden taşıma için 5000kg
kapasiteli forklift

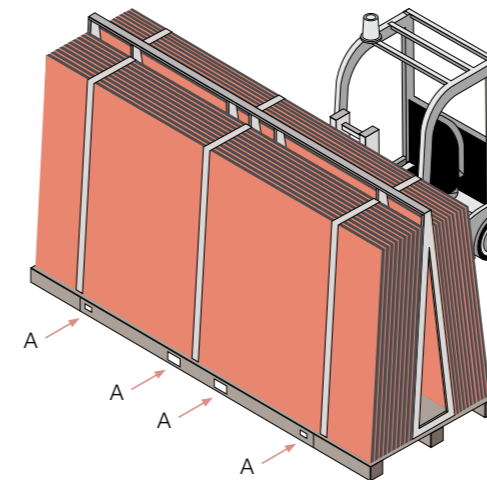

Forklift with 8000 weight (kg)
capacity to carry from direction A

B yönünden taşıma için 8000kg
kapasiteli forklift

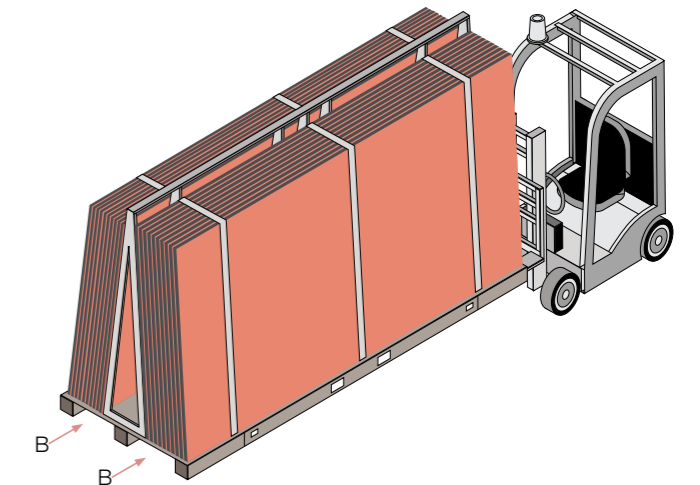

1.1.1. Loading / Unloading the Truck with A-Frame

1.1.1.1. Kamyon Üzerine A-Frame Yükleme/Boşaltma

To load and unload the trucks which have dropside bodies, fix the A-Frame by placing the forklift forks at two "A" gripping points and leaving at least a distance of 740mm between them. Forklift forks with a minimum length of 1200mm should be used to place the A-Frame in the middle of the truck.

To safely carry the products on the vehicles, fix the A-Frame's to the truck bed from the base and top. Use polyester or similar straps for this work. If you load several rows of A-Frame's, you should leave a distance of at least 50mm between them.

During loading and unloading, the operator should be careful about the people around. A-Frame should always be kept low while being carried and only be lifted when it is very close to the truck. You will find below an example of loading an A-Frame on a truck with a standard length of 13.60m.

Wooden boards having at least 7x9cm sizes, which are placed in the forklift lifting slots, are used to bolster the A-Frame's.

Kenarları açılan kamyonlara yüklemek ve boşaltmak için, forklift çatallarını en az 740mm forklift bıçak açıklığı olacak şekilde iki kavrama noktasına "A" yerleştirerek A-Frame'i sabitleyin. A-Frame kamyonun merkezi konumuna yerleştirmek için minimum 1200mm uzunluğa sahip forklift çatallar kullanılması gerekmektedir.

Araçlar üzerinde güvenli taşıma için, A-Frame'leri kamyon kasasına hem tabandan hem de yapının üst kısmından sabitleyin. Bu amaçla polyester veya benzeri kayışlar kullanın. Birkaç sıra A-Frame yüklerken arasında en az 50mm mesafe bırakın.

Yükleme ve boşaltma sırasında operatör çevredeki insanlara dikkat edilmelidir. A-Frame yük taşıma sırasında her zaman alçak tutulmalı ve yalnızca kamyonu çok yakın iken yukarı kaldırılmalıdır. Aşağıda 13,60m standart uzunluktaki bir kamyon için bir A-Frame yükleme örneği gösterilmiştir

A-Frame'leri desteklemek için forkliftin taşıma yuvalarından geçen en az 7x9cm kesitli latalar kullanılır.

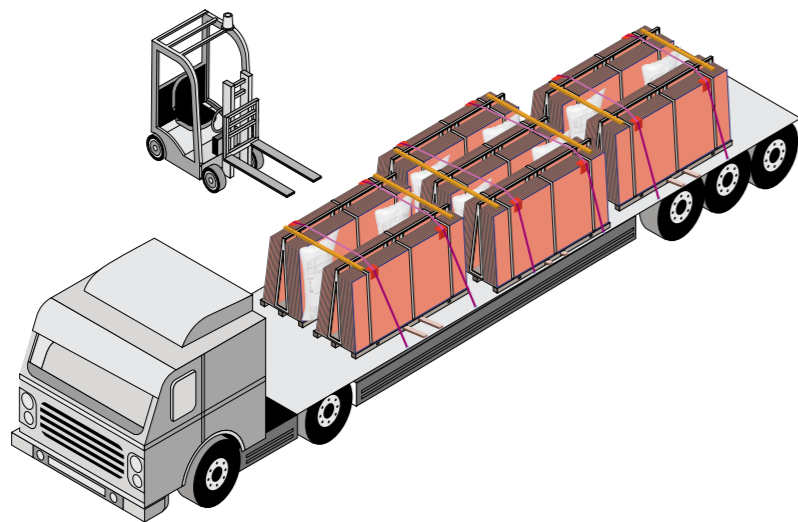

1.1.2. Domestic and International Highway Transportation with Truck Highway Transportation

1.1.2. Yurt içi ve Yurt dışı Karayolu Kamyon Taşıma

In international transportation with trucks, two A-Frame's are fixed to the vehicle chassis with at least two safety ropes. Airbag or styrofoam is used as abolster between the two A-Frame's.

Yurtdışı Kamyon ile taşımada, iki A-Frame en az 2 spanzet ile araç şasisine bağlanır ki A-Frame arasında destek olarak hava yastığı veya strafor kullanılır.

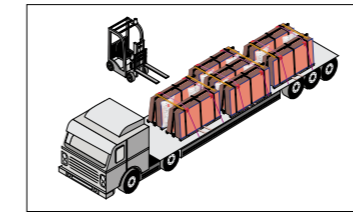
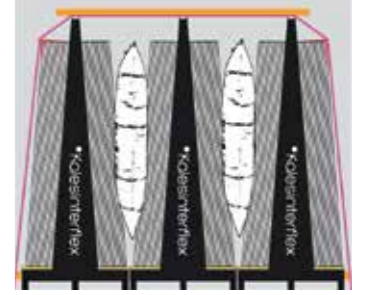

Domestic and international highway transportation with trucks.

Yurt içi ve yurt dışı karayolu kamyon taşıma.

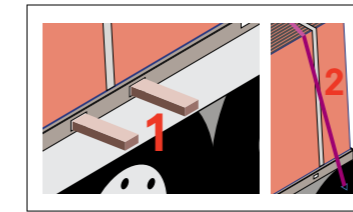
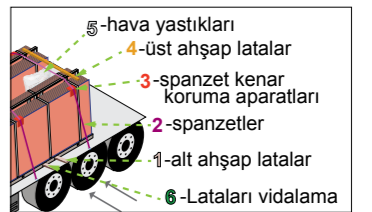
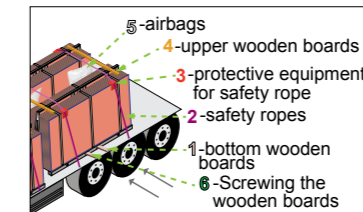

1- To support one or three A-Frame's in a row, two wooden boards, which have at least 7x9cm cross-sections and 240cm lengths, are used and placed in the forklift lifting slots.

2- A-Frame's are fixed to the trailer with at least two safety ropes that will pass through the top profile of the Frame's. **The safety ropes should not be over-tightened.**

1- Bir sıradaki 1 veya 3 A-Frame'leri desteklemek için, forkliftin taşıma yuvalarından geçen, 2 adet en az 7x9cm kesitli 240cm boyunda latalar kullanılır.
2- A-Frame'lerin en üst profilinden geçecek, en az 2 adet spanzet ile dorseye bağlanır. **Spanzetin aşırı sıkılmamasına dikkat edilmeli.**

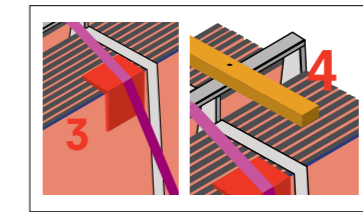

3- Spanzetlerin slab ürüne temas ettiği kenarlara koruyucu plastik destekler konur.

4- Bir sıradaki 2 veya 3 A-Frame'ler, vida yardımı ile üst profillerinden latalarla birleştirilerek hareket etmeleri kısıtlanır.

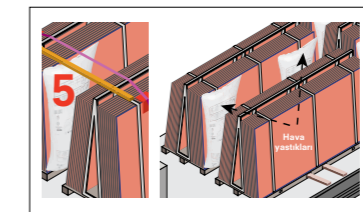

5- Her sıradaki A-Frame'lerin arasına ikişer adet dikey şekilde hava yastığı konur.

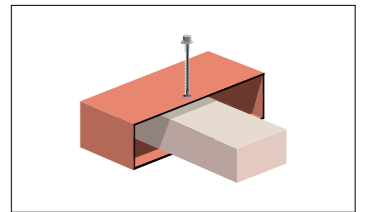

Wooden boards are screwed from the slots where the forklift forks are inserted. Two or three A-Frame's are fixed by screwing the wooden boards, which have been passed through the Frame's, to the outward-facing sides of the truck trailer. If there is no screw hole on the A-Frame, it is fixed with 5.5x90 DIN7504k, Hexagon drill-tip trapeze-panel screws with EPDM Rubber Washer.

Foklift bıçaklarının girdiği yuvalardan latalar vidalama yapılır ki veya üç A-Frame, içinden geçirilen latalar kamyon kasasında dışa bakan taraflardan vidalanarak sabitlenir. A-Frame'de hazır vida deliği yok ise 5,5x90 DIN7504k Altı köşe, Epdm Pullu,matkap uçlu trapeze-panel vidaları ile sabitlenir.

1.1.3. Loading / Unloading Container with A-Frame

1.1.3. Konteyner üzerine A-Frame Yükleme / Boşaltma

Use a pallet jack or forklift with a 8000kg load capacity and forks of at least 2800mm while the products are loaded on the container, and the container is unloaded. The operator moves the loaded A-Frame after taking and lifting the load with the help of the two "B" gripping points.

During loading, check the balance of the product by fixing the A-Frame's to each other and the towing platform. To carry the Frame's safely on the container, fill the gaps between the sca olds and between the sca old rows and airbags. Before the unloading, always check the methods used while locking the A-Frame's, to remove the locks.

Outside the container, carry the product by attaching the A-Frame's to the "A" gripping point every time.

Konteyner içine malzemenin yüklenmesi ve boşaltılması aşamalarında bir transpalet veya minimum 2800mm uzunluğunda çatallar ile donatılmış 8000kg kapasiteli bir forklift kullanın. Operatör, iki kavrama noktası "B" yardımıyla yükü alarak ve kaldırarak dolu A-Frame hareket ettirir.

Yükleme sırasında, A-Frame'ları birbirine ve çekme platformuna bağlayarak ve sabitleyerek malzemenin doğru dengesini kontrol edin. Konteyner üzerinde güvenli taşıma için, iskeleler arasındaki ve iskele sıraları arasındaki boşlukları hava yastıklarıyla doldurun.

Boşaltma aşamasından önce, kilitlerin etkili bir şekilde çıkarılmasını sağlamak için, daima A-Frame'ların kilitlendikleri yöntemi kontrol edin. Konteyner dışında, malzemeyi daima A-Frame'ları "A" kavrama noktasına tutturarak taşıyın.

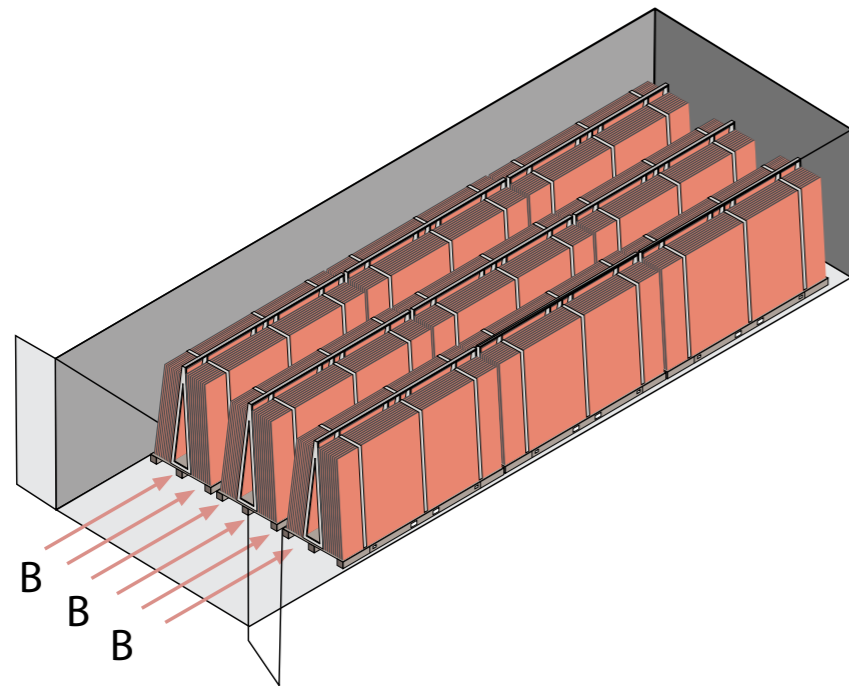

For loading /unloading the slabs, as seen in the picture below, a special lifting tool with belts, which is installed on a forklift having a load capacity of 5000-8000kg should be used. On the other hand, a crane equipped with a lifting arm, which is usually used to carry slabs, can be utilized.

Bu Plaka yüklenmesi / boşaltılması için, forklifte uygulanmış aşağıdaki resimdeki gibi vakumlu özel bir kaldırma ekipmanı veya alternatif olarak genellikle slab plakaları taşımak için kullanılan kaldırma kolu ile donatılmış bir vinç kullanılmalıdır.



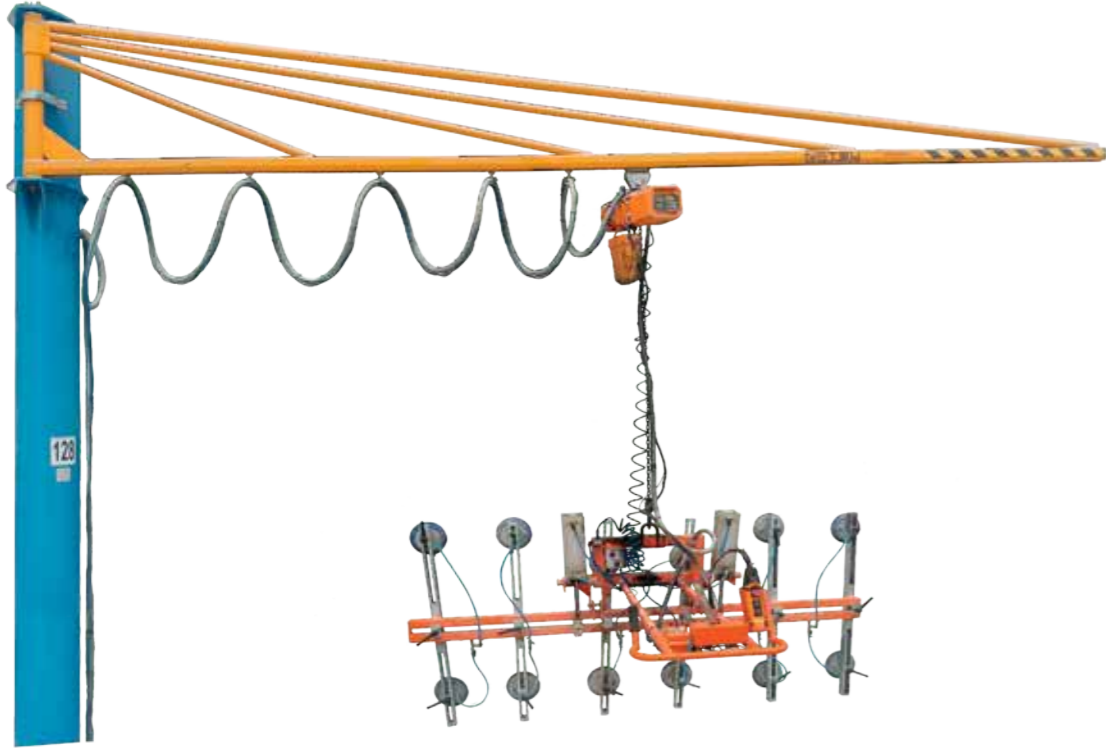

We recommend you use a similar tool and follow the same method to prevent imbalance and accidental damage during the unloading period.

Regardless of the method used for storing, other materials should not be put on Kalesinterflex porcelain slabs, especially on glossy surfaces.

If it is necessary to put them on top of each other, there should be no contact between the slabs. If the products are to be transferred from A-Frame to A-Frame one by one, precautions should be taken against surface damage that may occur.

Boşaltırken dengesizliği ve kazayla kırılmayı önlemek için benzer bir alet kullanmanızı ve aynı çalışma yöntemini takip etmenizi öneririz.

Depolama için kullanılan yöntem ne olursa olsun, Kalesinterflex porselen plakalar üzerine, özellikle parlak yüzeyler üzerine başka malzemelerin üst üste konmamasıdır.

Üst üste koymak gerekiyorsa, plakaların aralarından temas kesilmelidir. Ürünleri tekil olarak A-Frame den A-Frame'e aktarılırken oluşabilecek yüzey hasarlanmalarına karşı önlem alınmalıdır

1.1.4.Safety Criteria

1.1.4.Güvenlik Kriterleri

Instruction for Slab Loading / Unloading / Transportation

Porselen Plaka Yükleme / Boşaltma / Taşıma Talimatı

DİKKAT! ATTENTION!

Konteyner ve Tır/Kamyon yükleme ve boşaltma içindir.
Container and truck loading and unloading.

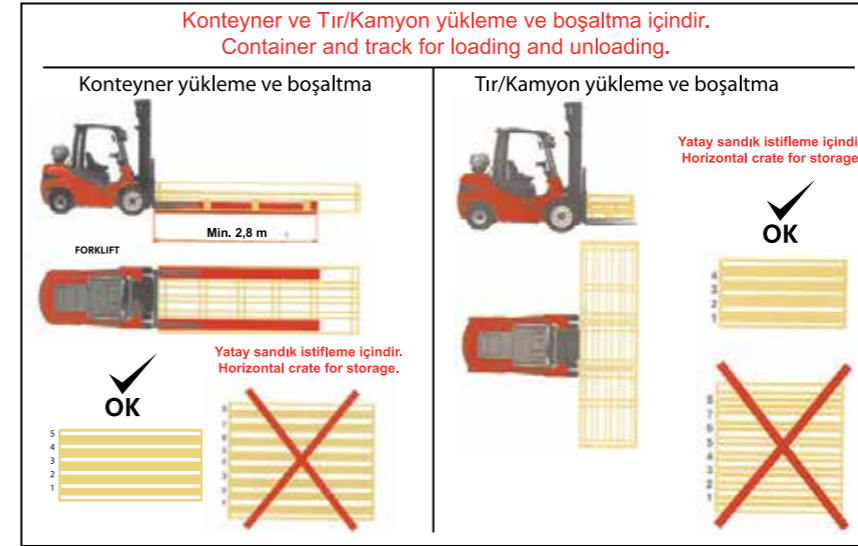

DİKKAT! ATTENTION!

Konteyner ve Tır/Kamyon yükleme ve boşaltma içindir.
For container and truck loading and unloading

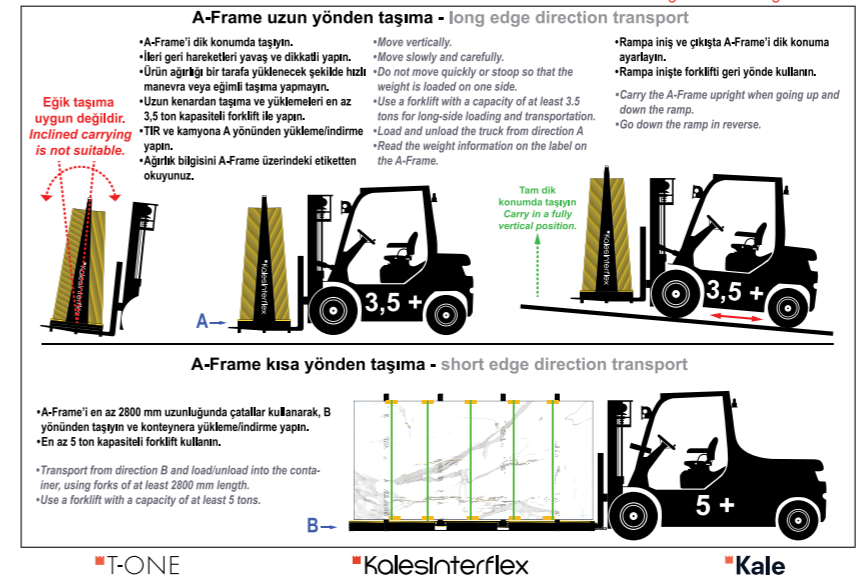

Kalesinterflex® AHŞAP YATAY AMBALAJ SANDIĞI AÇMA, BOŞALTMA VE ÜRÜN TAŞIMA TALİMATI

INSTRUCTION FOR OPENNING, UNLOADING AND HANDLING THE Kalesinterflex® HORIZONTAL WOODEN CASE

1. YATAY SANDIĞIN SADECE ÜST KAPASINI AÇIN. Kalesinterflex® İNCE KENARININ ÜZERİNE KALDIRIP (ŞEKİL 1), VAKUMLU TAŞIMA ARAÇLARI İLE VEYA YERE DİK TUTARAK SPANZET İLE TAŞIYIN. İNSAN GÜCÜ İLE TAŞIMA İÇİN EN AZ 5 KİŞİ EL VAKUMLU ARAÇLARI İLE YERE DİK OLARAK TAŞIMALIDIR.
2. Kalesinterflex® İ KESİNLİKLE YERE PARALEL ESNETEREK TAŞIMAYINIZ.
3. YATAY SANDIĞIN YAN TAVANLARINI AÇARAK BOŞALTMA KESİNLİKLE YAPMAYINIZ.
4. DOĞRU TAŞIMA YÖNTEMİ OLARAK AYRICA Kalesinterflex® İN YERE DİK TUTULMASI VANTUZ İLE 5 KİŞİ TARAFINDAN TAŞINMASI TAVSİYE EDİLİR.

1. OPEN ONLY THE TOP COVER OF THE HORIZONTAL CASE. LIFT Kalesinterflex® ON ITS THIN SIDE (Figure 1). CARRY IT WITH THE VACUUM CARRYING APPARATUS OR KEEP IT VERTICAL TO THE FLOOR WITH A SPANZET. FOR HANDLING WITH PEOPLE, AT LEAST 5 PEOPLE SHOULD CARRY IT UP TO THE GROUND WITH HAND VACUUM APPARATUS.
2. PLEASE DO NOT SEND THE SLAB IN A PARALLEL POSITION TO GROUND.
3. PLEASE DO NOT UNPACK THE PRODUCT BY REMOVING THE SIDE WALLS OF THE CASE.
4. FOR PROPER HANDLING, IT IS RECOMMENDED TO HOLD THE Kalesinterflex® VERTICALLY AND HANDLE THE SLABS WITH SUCTION CUPS BY TWO STAFF.

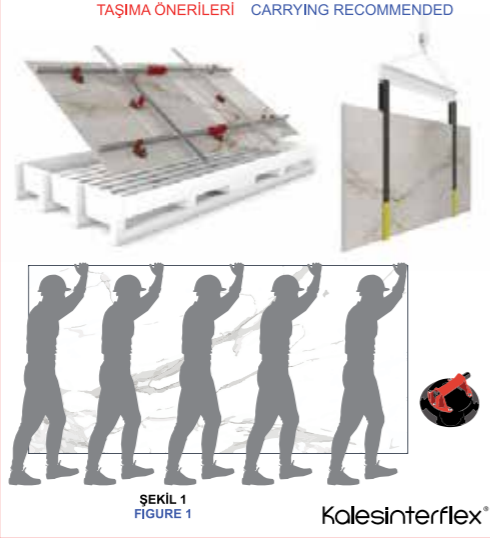
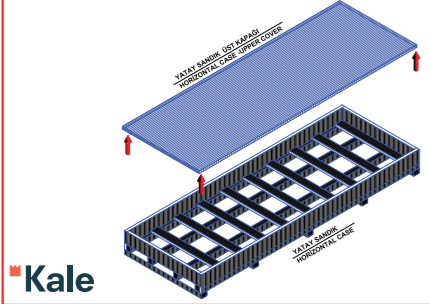

KALESİTERFLEX SANDIKLARININ YÜKLEME TALİMATI

LOADING INSTRUCTION FOR KALESİTERFLEX CHESTS

Aynı ebata sahip en fazla 4 sandık üstü üste istiflenebilir. Aynı boyuttaki sandıklar ayakları her yönden bir biri üzerine hizalanacak şekilde dizilir. **Ayaklar, kapağın destek-siz kısımlarına basmamalıdır.** Sandıklar ayaklarından birbirine lata (b) ile vidalanarak sabitlenir. Farklı boyutlarda sandıklar dizilirken küçük ve hafif olan büyük ve ağır olan üzerine konulur. Sandıklar arasında destek malzemeler (lata/kalas) (a) konulur ve kaymayı önlemek için ayaklardan lata (b) ile vidalanarak sabitlenir.

Tüm sandıklar spanzet ile kamyon kasasına veya konteynıra bağlanarak sabitlenir.

A maximum of 4 crates of the same size can be stacked on top of each other. Crates of the same size are arranged so that their legs are aligned on top of each other from all directions. Feet should not step on unsupported parts of the cover. The crates are fixed to each other by screwing their legs with laths (b). While crates of different sizes are arranged, the small and light ones are placed on top of the large and heavy ones. The legs are aligned on at least two edges, support materials (laths/planks) (a) are placed between the crates and the legs are fixed by screwing with laths (b) to prevent slipping. All crates are fixed to the truck or container with spanners.

■ Kale ■ Kalesinterflex

Instruction for Empty A-Frame Loading

Boş A-Frame Yükleme Talimatı

DİKKAT! ATTENTION!

Tır/Kamyon ile A-Frame taşıma içindir.
For A-Frame transportation by truck/TIR

Boş A-Frame taşıma talimatı - Empty A-Frame transport instructions

Matters to be considered in the loading instruction:

- Empty A-Frames should be loaded with a forklift from the side.
- There should be two people on the trailer for support during the loading.
- The first A-Frame in the figure is loaded first. The second A-frame is carried by the forklift and placed on the third A-frame with the support of the two people.
- The fourth A-frame is placed on the third A-frame and the wedge, as shown in the image, with the support of the two people.
- Each loaded A-Frame is tied and fixed with a safety rope or steel rope.

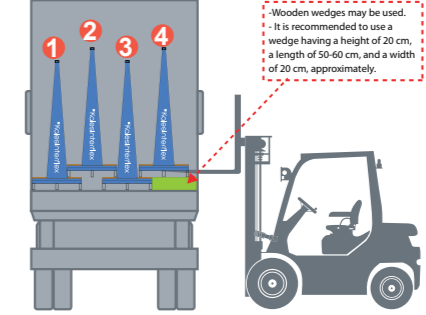

Loading horizontally a total of 16 pieces of 75x335x198cm A-Frames on the truck, in a row of 4x4, in 4 groups, each containing four frames

125kg x 16 = 2000kg (approximate tonnage)

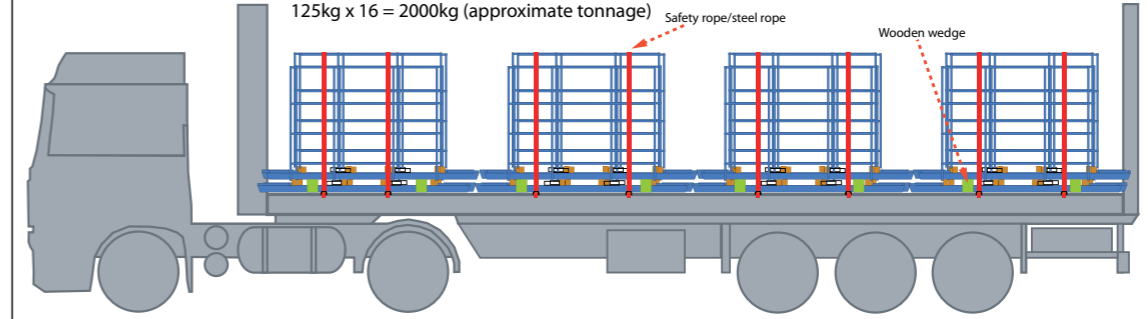

■ T-ONE

■ Kalesinterflex

■ Kale

1. Loading Instruction for Kalesinterflex Chests

1. Kalesinterflex Sandıklarının Yükleme Talimatı

- Up to 4 crates of the same size may be stacked on top of one another.
- Crates of the same size are lined by enabling their feet to overlap on top of one another from all directions. The feet should come across the unsupported parts of the cover. Crates are fixed to each other by screwing their feet to the wooden board (b).
- When lining up crates of different sizes, the small and light ones are placed on the large and heavy ones. Supporting materials (wooden board/plank) (a) are placed between the crates and **the feet of the crates are fixed by screwing them to the wooden board (b) to prevent slipping.**
- All crates are fixed by fastening them to the truck trailer or container with a safety rope.

- Aynı ebata sahip en fazla 4 sandık üst üste istiflenebilir.
- Aynı boyuttaki sandıklar ayakları her yönden bir biri üzerine hizalanacak şekilde dizilir. Ayaklar, kapağın desteksiz kısımlarına basmalıdır. Sandıklar ayaklarından birbirine lata (b) ile vidalanarak sabitlenir.
- Farklı boyutlarda sandıklar dizilirken küçük ve hafif olan büyük ve ağır olan üzerine konulur. Sandıklar arasına destek malzemeler (lata/kalas) (a) konulur ve **kaymayı önlemek için ayaklardan lata (b) ile vidalanarak sabitlenir.**
- Tüm sandıklar spanzet ile kamyon kasasına veya konteynıra bağlanarak sabitlenir.

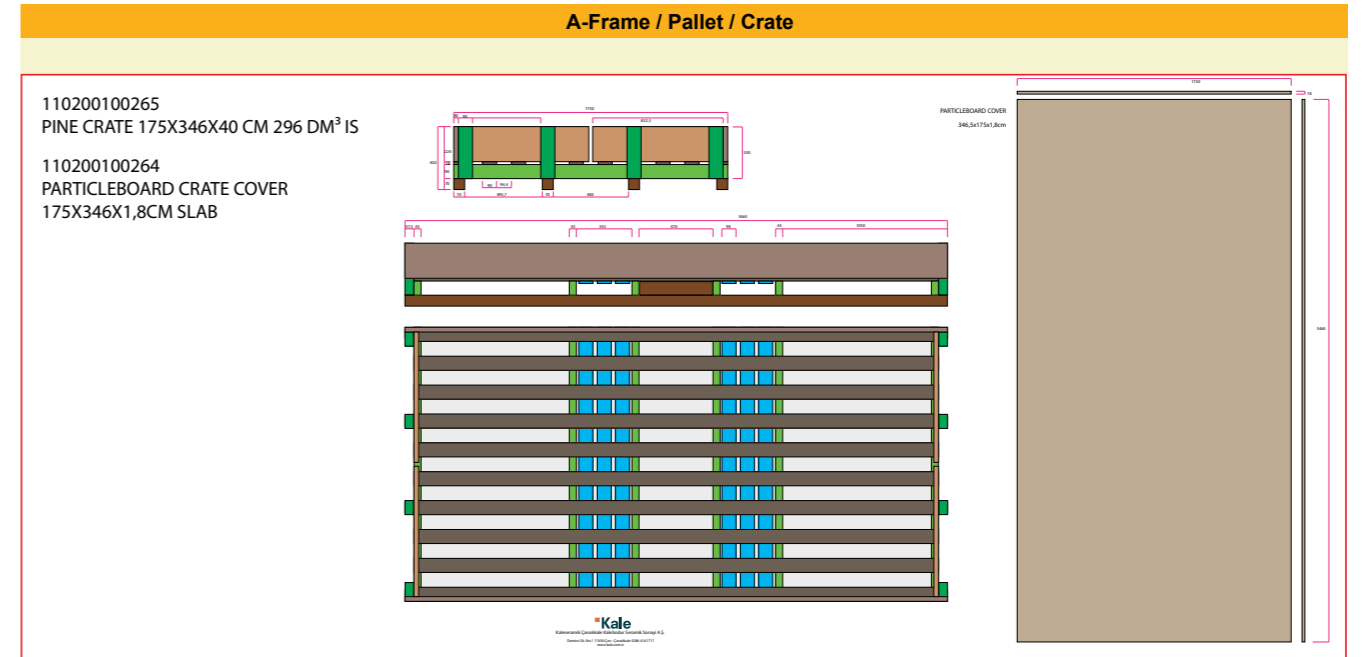
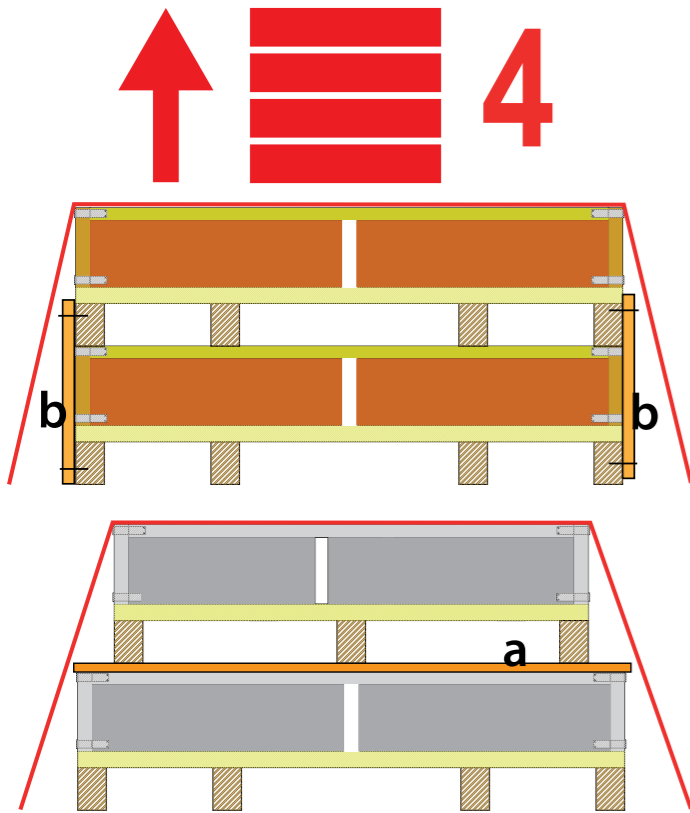

Product Index of Packaging Materials			
110200100265	PINE CRATE 175X346X40 CM 296 DM ³ IS	1 piece	
110200100264	PARTICLEBOARD CRATE COVER 175X346X1,8CM SLAB	1 piece	
110200600050	STYROFOAM 60x100x2cm	18 pieces-to bottom and uppermost	
110400100220	INSTRUCTION FOR SLAB-LOADING, UNLOADING AND CARRYING A&B	1 set (2 piece)	
110200400134	LABEL 20X15CM 160X320 6-6,5MM 14A BX	2 piece	
100200300086	STRETCH HOOD 2900-550-550 MM BX	1 piece	

Unit Quantity Definitions			
	Piece	Piece/Crate	40" Container
	1	14	15
m2	5,120	71,680	1075,2
Weight (kg)	73	1222	18330
Size	160x320		
Thickness	6-6,5 mm		
Row/Layer		14	

Labels and Marking / Tying		
<p>Part Label / Marking</p> <p>100x150mm parça etiketi</p>	<p>A-Frame/ Pallet / Crate Label</p> <p>Pallet label 150x100mm</p> <p>Instructions to be attached to the crate 110400100220 INSTRUCTION FOR SLAB-LOADING, UNLOADING AND CARRYING A&B</p> <p>DİKKATI / ATTENTION!</p>	<p>Tying</p> <p>110200400134 LABEL 20X15CM 160X320 6-6,5MM 14A BX</p>

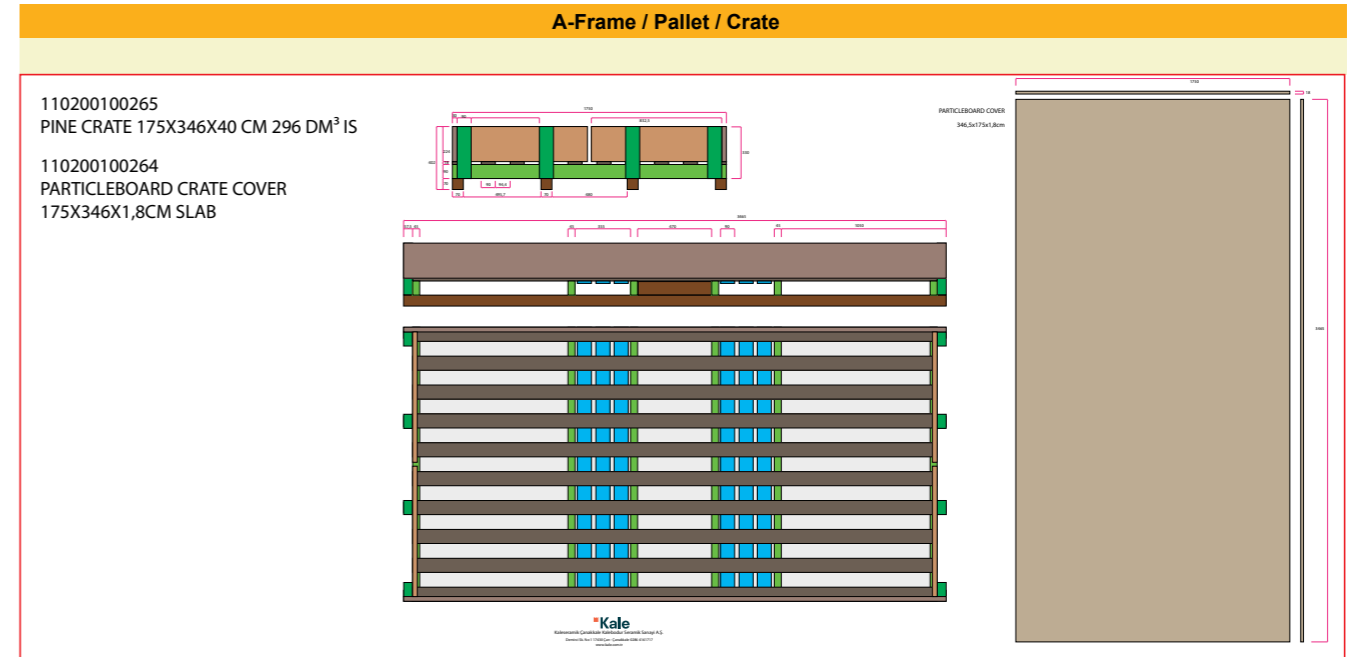
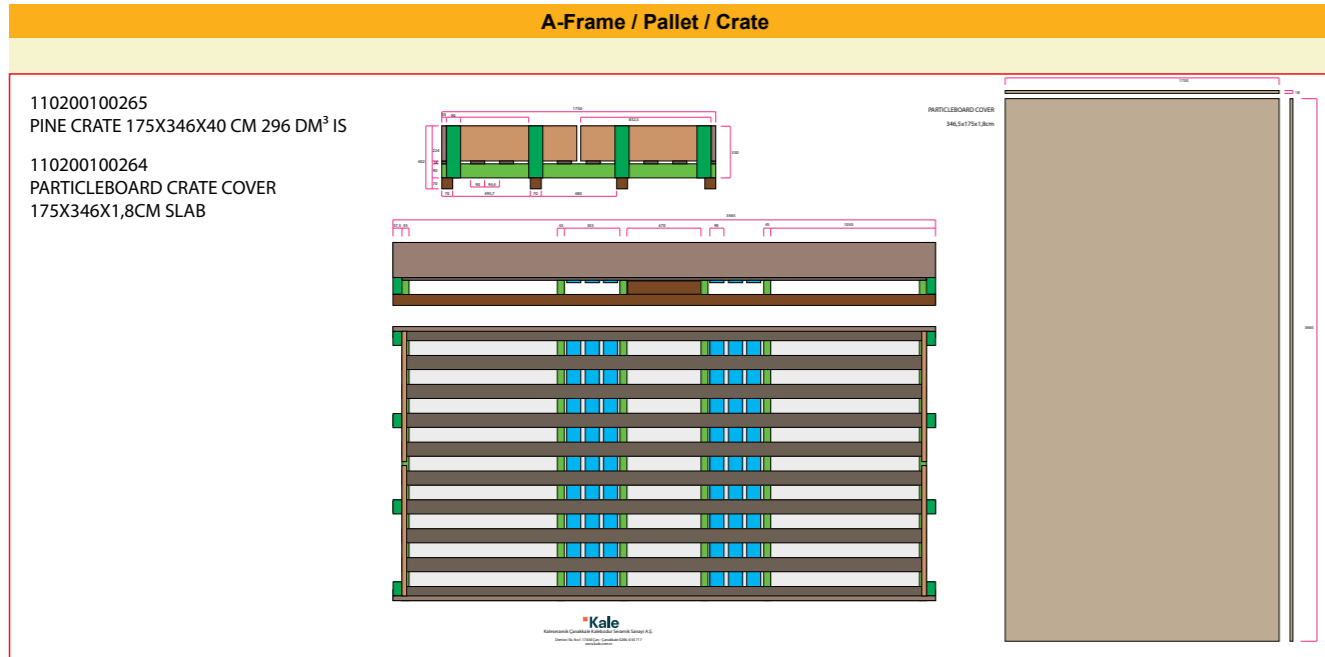

Product Index of Packaging Materials

110200100265	PINE CRATE 175X346X40 CM 296 DM ³ IS	1 piece
110200100264	PARTICLEBOARD CRATE COVER 175X346X1,8CM SLAB	1 piece
110200600050	STYROFOAM 60x100x2cm	18 pieces-to bottom and uppermost
110400100220	INSTRUCTION FOR SLAB-LOADING, UNLOADING AND CARRYING A&B	1 set (2 piece)
110200400134	LABEL 20X15CM 162X323 6-6,5MM 14A BX	2 piece
100200300086	STRETCH HOOD 2900-550-550 MM BX	1 piece

Unit Quantity Definitions

	Piece	Piece/Crate	40" Container
Piece	1	14	15
m2	5,23	73,22	1098,3
Weight (kg)	76,1	1265	18976
Size	162x323		
Thickness	6-6,5 mm		
Row/Layer		14	

Product Index of Packaging Materials

110200100265	PINE CRATE 175X346X40 CM 296 DM ³ IS	1 piece
110200100264	PARTICLEBOARD CRATE COVER 175X346X1,8CM SLAB	1 piece
110200600050	STYROFOAM 60x100x2cm	18 pieces-to bottom and uppermost
110400100220	INSTRUCTION FOR SLAB-LOADING, UNLOADING AND CARRYING A&B	1 set (2 piece)
110200400134	LABEL 20X15CM 160X320 12MM 6A BX	2 piece
100200300086	STRETCH HOOD 2900-550-550 MM BX	1 piece

Unit Quantity Definitions

	Piece	Piece/Crate	40" Container
Piece	1	6	15
m2	5,12	30,720	460,80
Weight (kg)	148,9	1093	16399,0
Size	160x320		
Thickness	12 mm		
Row/Layer		6	

Labels and Marking / Tying

Part Label / Marking	A-Frame/ Pallet / Crate Label	Tying
<p>100x150mm parça etiketi</p>	<p>2135800456 Pallet label 150x100mm</p>	<p>110200400134 LABEL 20X15CM 160X320 6-6,5MM 14A BX</p>
<p>Instructions to be attached to the crate 110400100220 INSTRUCTION FOR SLAB-LOADING, UNLOADING AND CARRYING A&B</p> <p>DİKKATI / ATTENTION!</p>		

Labels and Marking / Tying

Part Label / Marking	A-Frame/ Pallet / Crate Label	Tying
<p>100x150mm parça etiketi</p>	<p>2135800456 Pallet label 150x100mm</p>	<p>110200400139 LABEL 20X15CM 160X320 12MM 6A BX</p>
<p>Instructions to be attached to the crate 110400100220 INSTRUCTION FOR SLAB-LOADING, UNLOADING AND CARRYING A&B</p> <p>DİKKATI / ATTENTION!</p>		

A-Frame / Pallet / Crate

110200100265
PINE CRATE 175X346X40 CM 296 DM³ IS

110200100264
PARTICLEBOARD CRATE COVER
175X346X1,8CM SLAB

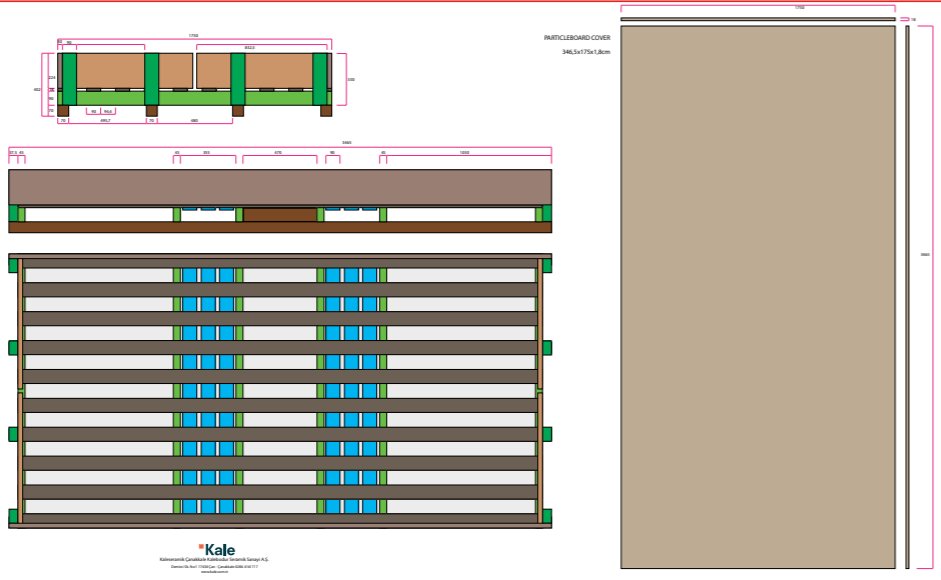

Product Index of Packaging Materials

110200100265	PINE CRATE 175X346X40 CM 296 DM ³ IS	1 piece
110200100264	PARTICLEBOARD CRATE COVER 175X346X1,8CM SLAB	1 piece
110200600050	STYROFOAM 60x100x2cm	18 pieces-to bottom and uppermost
110400100220	INSTRUCTION FOR SLAB-LOADING, UNLOADING AND CARRYING A&B	1 set (2 piece)
110200400134	LABEL 20X15CM 162X323 12MM 6A BX	2 piece
100200300086	STRETCH HOOD 2900-550-550 MM BX	1 piece

Unit Quantity Definitions

	Piece	Piece/Crate	40" Container
Piece	1	6	15
m2	5,23	31,38	470,7
Weight (kg)	152,2	1113,0	16694,0
Size	162x323		
Thickness	12 mm		
Row/Layer		6	

Labels and Marking / Tying

Part Label / Marking



100x150mm parça etiketi

A-Frame/ Pallet / Crate Label



Pallet label 150x100mm

Tying

Instructions to be attached to the crate
110400100220 INSTRUCTION FOR SLAB-LOADING,
UNLOADING AND CARRYING A&B

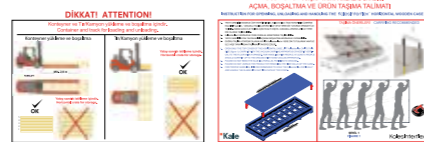

CERTIFICATES | SERTİFİKALAR



SYMBOLS | SEMBOLLER



Hotel
Otel



Business Center
İş Merkezi, Ofis



Shopping Center
Alışveriş Merkezi



Frost Resistance
Dona Dayanıklılık



Residence
Konut



Factory
Fabrika



Facade
Dış Cephe



Restaurant, Cafe
Restoran, Kafe



Pool
Havuz



Outside
Dış Mekan



Hospital
Hastane



Wall Tiles
Duvar Karosu



Floor Tiles
Yer Karosu

SHADE VARIATION | RENK TON FARKLARI



V1
Uniform Appearance
Aynı Görünüm



V2
Slight Variation
Hafif Farklılık



V3
Moderate Variation
Önemli Farklılık



V4
Random Variation
Rastgele Farklılık

Kale

Kaleseramik Çanakkale Kalebodur Seramik San. A.Ş.
Büyükdere Cad. Kaleseramik Binası 34330 Levent - İstanbul / Türkiye
T: 0850 800 5253

kale.com.tr